

# Connector Theory and Application



Connecting Power to Your World®



# Connector Theory and Application

## A Guide to Connection Design and Specification

Revised 5th Edition

### Authored by:

GARY DITROIA  
IEEE MEMBER  
BURNDY LLC  
47 East Industrial Park Drive  
Manchester, NH 03109 USA

RONALD LAI  
IEEE Life Senior Member  
ASME Life Member  
SAE Life Member  
Consultant to BURNDY LLC

KENNETH WOO  
BURNDY LLC  
47 East Industrial Park Drive  
Manchester, NH 03109 USA

GAYLORD ZAHLMAN  
BURNDY LLC  
47 East Industrial Park Drive  
Manchester, NH 03109 USA

# Table of Contents

## Introduction

## 1.0 Theory of Connector Technology

### 1.1 Grounding (Earthing) and Bonding

- 1.1.1 Corrosion
- 1.1.2 Fault Current
- 1.1.3 Special Grounding Applications
- 1.1.4 Ground Connection Design

### 1.2 Substation

- 1.2.1 Distribution Substations
- 1.2.2 Conductors
- 1.2.3 Substation Connector Design

### 1.3 Underground Distribution

- 1.3.1 Design Objectives
- 1.3.2 Underground Secondary Networks
- 1.3.3 Special Considerations
- 1.3.4 Network Protection

### 1.4 Overhead

- 1.4.1 Thermal Expansion and Contraction
- 1.4.2 Mechanical Integrity
- 1.4.3 Dielectric Fundamentals
- 1.4.4 Corrosion
- 1.4.5 Performance Testing (ANSI C119.4)

### 1.5 Service Entrance

- 1.5.1 Secondary Conductor
- 1.5.2 Service Connectors

### 1.6 Telecommunication

- 1.6.1 Telecommunication Conductors
- 1.6.2 Telecommunication Connections

## 2.0 Connector Functions and Types

### 2.1 Functions

- 2.1.1 Tap
- 2.1.2 Terminal
- 2.1.3 Splice

### 2.2 Types of Connectors

- 2.2.1 Mechanical Connectors

- 2.2.1.1 Connector Material
- 2.2.1.2 The Clamping Element
- 2.2.1.3 Advantages of Mechanical Connectors
- 2.2.1.4 Disadvantages of Mechanical Connectors
  
- 2.2.2 Wedge
  - 2.2.2.1 Advantages of Wedge Connectors
  - 2.2.2.2 Disadvantages of Wedge Connectors
  
- 2.2.3 Automatic Connectors
  - 2.2.3.1 Advantages of Automatic Connectors
  - 2.2.3.2 Disadvantages of Automatic Connectors
  
- 2.2.4 Insulation Piercing Connectors (IPC)
  - 2.2.4.1 Advantages of Insulation Piercing Connectors
  - 2.2.4.2 Disadvantages of Insulation Piercing Connectors
  
- 2.2.5 Compression Connectors
  - 2.2.5.1 Advantages of Compression Connectors
  - 2.2.5.2 Disadvantages of Compression Connectors
  
- 2.2.6 Welded Connections
  - 2.2.6.1 Advantages of Welded Connections
  - 2.2.6.2 Disadvantages of Welded Connections
  
- 2.2.7 Exothermic Weld Connections
  - 2.2.7.1 Advantages of Exothermic Weld Connections
  - 2.2.7.2 Disadvantages of Exothermic Weld Connections
  
- 2.2.8 Split Solder Sleeves
  - 2.2.8.1 Advantages of Split Solder Sleeves
  - 2.2.8.2 Disadvantages of Split Solder Sleeves
  
- 2.2.9 Implosive Connections
  - 2.2.9.1 Advantages of Implosive Connections
  - 2.2.9.2 Disadvantages of Implosive Connections
  
- 2.2.10 Solar Electrical Panel Connections
  
- 2.3 Application and Performance Testing
  - 2.3.1 General Test Parameters
  
- 3.0 Practical Connector Concepts
  - 3.1 Installation
    - 3.1.1 General Practice
      - 3.1.1.1 Contact Surface Preparation

- 3.1.1.2 Insulation Removal
- 3.1.1.3 Oxide Inhibitors
- 3.1.1.4 Hardware
  - 3.1.1.4.1 Terminal Hardware Considerations
- 3.1.1.5 Aluminum Above Copper
- 3.1.1.6 Plating
- 3.1.1.7 Sealed Tongue Terminals
- 3.1.1.8 Standard Wall and Heavy Wall Compression Connections

### 3.1.2 Wedge Installation

### 3.1.3 Compression Installation

- 3.1.3.1 Cable Insertion
- 3.1.3.2 Bias Cuts
- 3.1.3.3 Compression Installation Tooling
- 3.1.3.4 Bowing (“bananaing”)
- 3.1.3.5 Bird-caging
- 3.1.3.6 Spaced and Overlapped Crimps
- 3.1.3.7 Crimp Configurations
- 3.1.3.8 Conductor Stranding and Materials
  - 3.1.3.8.1 Concentric, Compressed and Compact Conductor
  - 3.1.3.8.2 High Temperature Conductors (ACSS, ACCC, ACCR)

## 3.2 Infrastructure

### 3.2.1 Total Cost of Ownership

- 3.2.1.1 Up-front Costs
- 3.2.1.2 Installation Costs
- 3.2.1.3 Maintenance Costs
- 3.2.1.4 Cost of Failure

## 3.3 Safety

### 3.3.1 Installation Safety

- 3.3.1.1 Industry Standards
- 3.3.1.2 Manufacturer’s Guidelines
- 3.3.1.3 Internal Safety Programs

### 3.3.2 Improper Handling and Use

- 3.3.2.1 Storage
- 3.3.2.2 Inspection
- 3.3.2.3 Transportation
- 3.3.2.4 Tool Selection and Use
- 3.3.2.5 Improper Application

## 4.0 Summary

## 5.0 Bibliography

## Table of Figures

Figure 1.0-1	Asperities between two surfaces
Figure 1.1-1	Galvanic corrosion between a steel ground rod and a copper connector
Figure 1.1-2	Structural Steel Connection
Figure 1.2-1	Distribution Substation
Figure 1.2-2	Mechanical Substation Connector
Figure 1.3-1	Radial Network
Figure 1.3-2	Secondary Network
Figure 1.4-1	Aluminum above Copper when outdoors
Figure 1.6-1	Imprinted Logo & Die Index Number of Terminal
Figure 2.1-1	A Mechanical Tap Connection
Figure 2.1-2	Variety of Terminal Connections
Figure 2.1-3	Copper (left) and Aluminum (right) Splice Connectors
Figure 2.2-1	A Mechanical Tap or Splice Connector
Figure 2.2-2	Wedge Connector Components
Figure 2.2-3	Automatic Splice
Figure 2.2-4	Installing an Insulation Piercing Connector
Figure 2.2-5	Components needed to make a compression installation
Figure 2.2-6	Welded T Connection and Bus Supports
Figure 2.2-7	A graphite mold for exothermic welding
Figure 2.2-8	Implosive terminal with energy wrap prior to installation
Figure 2.2-9	The cross section of an installed IMPLO <sup>®</sup> sleeve
Figure 2.2-10	Multiple IMPLO <sup>®</sup> deadends being installed
Figure 2.2-11	Six IMPLO <sup>®</sup> splices passing through stringing block
Figure 2.2-12	Typical storage magazines for implosive connections
Figure 2.2-13	Example of a solar cell
Figure 2.2-14	A solar module or panel
Figure 2.2-15	Bonding washer embedded in Al matrix
Figure 2.2-16	Photomicrograph of metal after removal of WEEB <sup>®</sup> washer
Figure 3.1-1	Bolted Joints
Figure 3.1-2	Bolt Force Relaxation Curve
Figure 3.1-3	Al above Cu when installed outdoors
Figure 3.1-4	Service Drop Drip Loop
Figure 3.1-5	A completed wedge connection
Figure 3.1-6	Wedge Connection Installation Tool
Figure 3.1-7	Manufacturer's mark embossed on end of wedge by installation tool
Figure 3.1-8	Battery Powered Hydraulic Crimp Tool
Figure 3.1-9	Compression Splice
Figure 3.1-10	Compression Terminal
Figure 3.1-11	Compression Tap
Figure 3.1-12	Crimp Configurations
Figure 3.1-13	Nest and Indentor Configuration
Figure 3.1-14	Dieless Configurations



## Table of Tables

Table 1.3-1	Limiter Protected Cable Types
Table 1.4-1	ANSI C119.4 Current Cycle Classes
Table 1.4-2	Tension Classes
Table 2.3-1	Canadian/Mexican/National Electrical Codes Related Standards
Table 2.3-2	NESC (Utilities) Related Standards
Table 3.1-1	Bolted Joints
Table 3.1-2	Recommended Tightening Torque
Table 3.1-3	Cross-Sectional Ampacity
Table 3.1-4	Amperes per Bolt Influence Area
Table 3.1-5	Plating Applications
Table 3.1-6	Summary of Standard and Heavy Wall Tension Tests
Table 3.1-7	Summary of Standard and Heavy Wall Current Cycle Tests





# Introduction

Electrical connectors, in their simplest form, join two or more conductors in a continuous, electrically conductive path. This paper introduces various connector applications and their related conditions to consider when selecting an appropriate means of electrical connection. We recommend basing the selection of an electrical connector first on sound technical reasoning, and then from the ensuing options finalize a selection around three fundamental criteria - safety, reliability, and cost - for the specific application. It is the intent of the authors to provide the technical background enabling sound judgment when selecting an appropriate means of connection suitable for a particular application.

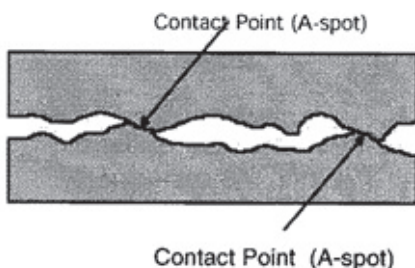
## 1.0 THEORY OF CONNECTOR TECHNOLOGY

An all-encompassing treatise on connector theory can become quite involved and confusing if not subdivided into manageable topics. Indeed, even with a topical outline, there are numerous issues that can, and will, overlap from one discussion to another. Regardless of the means of connection, its application, or its function, however, all electrical connections have one primary objective; to provide a path of electrical conduction between the conductors being joined. An inherent result of this objective is that an electrical connection must exhibit low bond, or contact, resistance. Secondly, the connection must be durable and robust in order to maintain low contact resistance and withstand mechanical forces and corrosion that will act to deteriorate the connection over time.

Two conductor surfaces in contact (e.g. connector and cable) can never be perfectly matched. On a microscopic level, each surface resembles rough terrain with peaks and valleys. When the two surfaces come together, the peaks from one will randomly match up with those on the other surface. Where direct contact occurs between the peaks (known as asperities or “A-spots”) of each surface, the resistance between the surfaces becomes theoretically zero; i.e., there is no voltage drop across the immediate interface.

In actuality, however, there may be very few points of direct, metal-to-metal contact between the two surfaces (see Figure 1.0-1). When voltage is applied across the mating surfaces, current will flow, but only through the contact points. The restriction of current flow to these few points constitutes the contact resistance.

For an electrical connector to achieve its objective, therefore, it must develop as many true electrical contact areas as possible with the conductor. Whether in the case of pressure-applied connectors (mechanical and compression technologies where asperities are flattened, broadened, and increased in quantity), or fusion connections (soldering, brazing and welding technologies where the application of heat and the introduction of a joining medium create an alloyed boundary), a connection’s quality, as defined by low contact resistance, will be determined by the electrical contact area established at the time of installation. Thus, a connector’s long term performance is directly related to the electrical contact area originally established. However, not only must the connector’s true electrical contact area be maximized at the moment of installation; it must also be maintained over the intended life of the connection.



Although the premise of creating an electrical connection seems simple, many factors influence a connection’s ability to first establish, and then maintain, a low contact resistance. Surface contaminants or corrosion will interfere with establishing initial contact, thermal fatigue can loosen the connector and reduce the number of contact points, and mechanical stress and long term corrosion can diminish surface contact directly or indirectly by attacking the structural integrity of the connector.

**Figure 1.0-1 Asperities between two surfaces.**

These subjects, and many others, will be reviewed in the balance of this treatise. By subdividing the many topics to be covered, as alluded to earlier, the main issues concerning effective electrical connector design, specification, and installation may be more fully addressed. The subdivisions described below provide the foundation to begin coverage of the important concepts of connector theory.

- Generation
- Transmission
- Substation
- Grounding and bonding
- Underground distribution
- Overhead distribution, bare and insulated
- Service entrance
- Telecommunication

The primary application of a circuit usually determines the selection of the wiring or bus work needed to transmit electrical energy and is often the first piece of information that the electrical technician is given. That purpose will also define the connection type and category as not all products are suitable for all types of connections. Development of the theory will be based on the category of the connections.

The next means for connector differentiation, leading to eventual selection/specification, is its secondary function by type. There are three general connector functions; to tap, to terminate, and to splice. Although some overlap can occur here, a connector will usually be of a specific type that allows this distinction. Section 2.0 describes the fundamental differences between these functions and potential areas of overlap in order to provide a consistent basis to define and differentiate a connection.

Finally, there are various means of connections that allow a connector to perform its function within an application. Section 2.2 deals with the various means of connections, or connector types (mechanical, compression, wedge, fusion, etc.) in detail to provide an understanding of the theory behind the technology employed.

## **1.1 Grounding (Earthing) and Bonding**

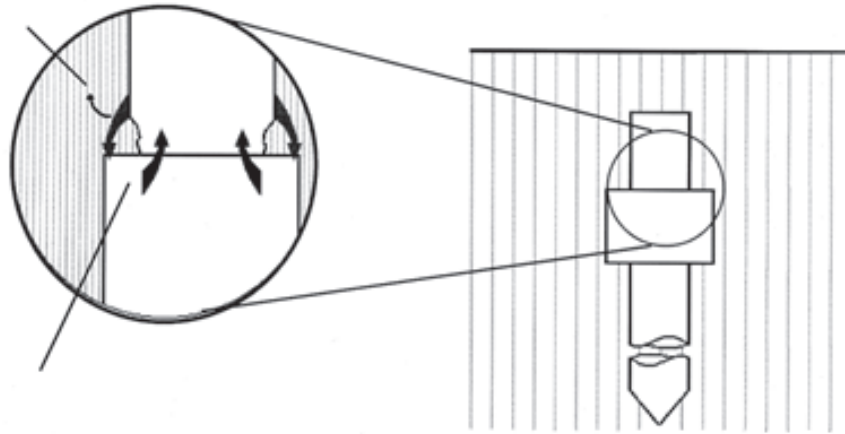
There are several main objectives for providing a well-designed ground system; safety of personnel tops the list, followed by equipment protection, signal reference quality, return path for faults and/or surges allowing over-current protection devices to work properly, and static dissipation. In order to meet these objectives, ground system interconnections must maintain a low contact resistance, often under adverse conditions, for the expected life of the grounding system. Connections in a ground network are subject to severe corrosion, high mechanical stress due to electromagnetic forces, and rapid thermal heating due to high current magnitudes during fault conditions.

### **1.1.1 Corrosion**

Grounding connections have applications both above and below grade and as such, are subject to various kinds of corrosion.

Above grade corrosion takes place mainly through galvanic action when two metals are exposed to an electrolyte. This type of corrosion is most pronounced when the connector material differs significantly from the conductor material in nobility. In the presence of an electrolyte solution, a galvanic cell forms allowing direct current (ions) to flow from the more positive anodic to the more negatively charged cathodic material. Over time, the loss of material at the connection interface whether it is from the connector or conductor will cause an increase in electrical resistance resulting in a reduction in overall performance and possibly eventual failure. Like-metals in direct contact are less subject to galvanic corrosion because they are close in electrical potential.

Below grade (connections in direct contact with the earth) environments will also subject a connection to conditions that cause galvanic corrosion (see Figure 1.1-1). In addition, below grade connections are subject to acidic corrosion. Soil conditions may vary greatly from one location to the next, and soil pH will vary accordingly. Acidic soils can be especially harsh on alloy materials. For example, high-zinc brasses generally perform poorly in naturally occurring acidic ground soils. Alternatively, pure copper and high copper content alloys usually perform very well in most soil conditions.



**Figure 1.1-1 Galvanic corrosion between a steel ground rod and a copper connector**

## 1.1.2 Fault Current

The primary task of the ground system, to safely conduct fault currents to ground, is also a leading source of stress on ground connections. Electromagnetic forces develop quickly and mechanically stress the entire ground system, including the connection points. The magnitude and direction of the mechanical force are related to the path of conduction, conductor proximity, and the fault current magnitude.

In addition to the physical strain, ground connections must also withstand high thermal shock due to the passing of fault current. Depending on how the ground system electrodes were sized and the duration of the fault, conductor temperatures may reach 250°C (maximum for copper in tension applications) to well in excess of 600°C (copper melts at 1085°C). The connector must be capable of handling these extreme temperatures without loss of integrity.

## 1.1.3 Special Ground Applications

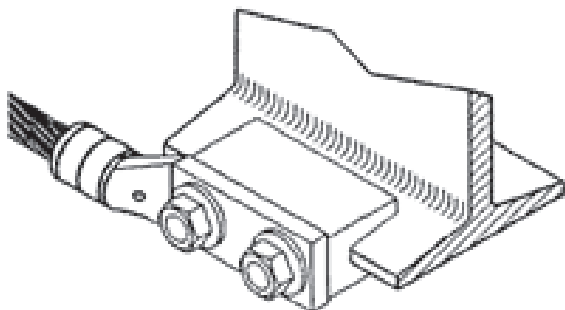
Special conditions arise in the ground system when considering all structures that require bonding to the ground network. In order to protect personnel from hazardous voltage potentials, non-circuit, conductive structures such as fences, water pipes, and structural steel need to be bonded to the ground system. These structures often require special considerations for connection due to their materials and geometric configuration.

Fence posts, gates, mesh and barbed wire often require bonding to the ground system. Post connections require connectors suitable for a pipe shaped geometry. Connections to gates require flexibility to resist breakage from repeated opening and closing.

Connections to pipes (including posts, water pipes, conduit, etc.) are subject to galvanic corrosion, especially when the pipes are iron derivatives. Most pipe connectors are mechanical and made of copper or copper-based alloys to ensure a long lasting connection to the ground lead. Mechanical connectors allow for

connecting directly to the circumference of the pipe, although in low current applications a connection made at the pipe flange is also suitable.

In some instances, connections to pipe are made by welding. However, before welding to a pipe, it is necessary to fully understand its usage. The pipe wall or flange may be structurally weakened by the intense heat of the welding process, and could eventually lead to an operational failure. Damage may also occur to any plating or coating protecting the pipe from corrosion. When in doubt as to the extent of damage that the weld will cause, it is best either to contact or refer to the connector manufacturer's literature to determine suitability.



Connecting to structural steel has similar requirements to those described for pipe including unique configuration, potential for corrosion, and structural dependence. Many structure design engineers and architects will not allow drilling or welding to the steel I-beams or rebar. As a result, alternate connection means are necessary. Figure 1.1-2 depicts a mechanical I-beam connector with compression ground rod connections used in a temporary ground application.

**Figure 1.1-2 Structural Steel Connection**

Corrosion protecting coatings are an important consideration when making connections to non-circuit components.

Painted enclosures or epoxy covered surfaces must be stripped of these non-conductive coatings before connections are made. Where epoxy coatings are not allowed to be removed, alternate means of bonding must be found. With plated surfaces such as galvanized steel, however, the plating should not be removed. Plating materials are applied to increase the longevity of the primary function of the item. In these cases, it may not be possible to use welding to make connections. The extreme heat will melt the plating and expose the base material to corrosion.

Regardless of the type of finish present, the area of contact should be cleaned and a suitable oxide inhibiting compound applied prior to making the connection. In addition, connections to the ground system should be made on both sides of non-metallic couplers; for example, those used for joining pipe sections.

### 1.1.4 Ground Connection Design

Copper conductor is the premier choice for constructing ground systems. Having excellent electrical conductivity, copper dissipates thermal energy quickly and is resistive to corrosion. Ground connectors should have these properties to ensure similar performance. Copper and high copper content alloys are used to minimize galvanic corrosion with copper ground conductors, to increase longevity in below grade applications, and to withstand the rigors of repeated fault currents.

For Canadian/Mexican/National Electrical Code applications, the minimal requirement for ground connectors should be the ability to meet the requirements of the harmonized tri-national standard ANCE NMX-J-590, CSA C22.2 No. 41, UL 467 *Safety Standard of Grounding and Bonding Equipment*. By meeting the requirements in this standard, the user can be confident that the connector is likely greater than 80% copper (if marked "direct burial") and has withstood a short time current test. If the connector is made of a material containing less than 80% Cu, it is in addition subjected to corrosion testing to determine if it can be used in the ground. Alternate connector testing may be substituted, but none should require less than the criteria in the above standard.

For National Electrical Safety Code (NESC) applications, IEEE STD 837 *Standard for Qualifying Permanent Connections Used in Substation Grounding* exceeds the requirements of all other ground connection

performance standards. The testing in IEEE STD 837 closely simulates and often exceeds the conditions seen by ground connections. Mechanical strength and electrical resistance stability are tested with pullout and electromagnetic force tests, and longevity is proved through a sequence of tests on the same set of connector-cable specimen that go through static heat cycling, freeze-thaw cycling, corrosion exposure (acidic or alkaline), and finally fault current. Connectors meeting IEEE STD 837 requirements are suitable for all grounding and lightning protection applications and require no special considerations, such as temperature de-rating.

## 1.2 Substation

Substations are the source of energy-supply for local area distribution, select user sites, or even a specific customer. The main function of the substation is to step down voltage from the transmission or sub-transmission level to the distribution level. In order to serve this purpose, substations make use of various devices for safety, switching and voltage regulation, and measurement. Substations are usually located at or near the center of the distribution area, may be indoors or exposed outdoors, and operated manually or automatically.

### 1.2.1 Distribution Substations

A substation that is centrally located within the load area is called a distribution substation. Distribution substations may be as close as two miles from each other in densely populated areas. These substations may also be located near a large manufacturing facility or inside a high-rise building to supply the needs of high density and/or high-load customers.



**Figure 1.2-1 Distribution Substation**

Distribution substations contain many components, as seen in Figure 1.2-1, a few of which are power transformers, circuit breakers, and voltage regulators. The power transformers are the heart of the distribution substation, performing the main task of stepping down sub-transmission voltages to distribution voltages (normally ranging from 4.16Y/2.4 kV to 34.5Y/19.92 kV). Circuit breakers are placed between the distribution circuits and low-voltage bus for substation protection during fault or surge conditions. Voltage regulators are installed in series on each distribution circuit if the power transformers are not equipped with automatic tap changing capabilities that enable bus voltage regulation.



## 1.2.2 Conductors

Bus (or bus bars) is the main current carrying conductors within a substation. Buses are constructed of either copper or aluminum, and are supplied in many configurations, including rectangular bars, round tubing, square tubing, stranded cables, and solid circular bars. They are also available both insulated and bare depending on requirements.

## 1.2.3 Substation Connector Design



**Figure 1.2-2 Mechanical Substation Connector**

The challenge for substation connector designs is to meet both the dimensional and electrical constraints. Mechanical connectors are often used for substation connections due to their adaptability to accommodate different conductor sizes. With these connectors, fastening hardware is usually located as close to and on opposing sides of the conductor to provide uniform clamping. (See Figure 1.2-2)

As aforementioned, transformers are the main pieces of equipment within the distribution system. Many types of transformers exist (pole, vault, pad-mount, submersible, direct-buried, etc.) however, the methods of connecting to them are generally similar. Each transformer will have primary (high-voltage) and secondary (low-voltage) bushings to which connections are to be made.

Proper connector selection is crucial for providing efficient, long-term performance of the equipment to conductor connection. One type that has been used successfully on primary bushings is the pin terminal to an eye-and-basket connection. The pin terminal is crimped to the wire conductor and then inserted into the eye-and-basket tap, which is then tightened to the manufacturer's recommended torque value.

The secondary bushings may be fitted with a bus, allowing connections to multi-wire services via bus clamps and supports. Other terminations include multi-tap terminal adapters, stacking (spacer) adapters, and threaded spade/stud terminals.

All connections made to the distribution transformer must be capable of withstanding the rigors of the environment. Outdoor distribution equipment is exposed to wind, rain, temperature extremes, snow and ice. Indoor equipment (e.g. unheated buildings, manholes, and vaults) is subject to moisture, flooding, extreme temperatures, crowded space, and corrosion.

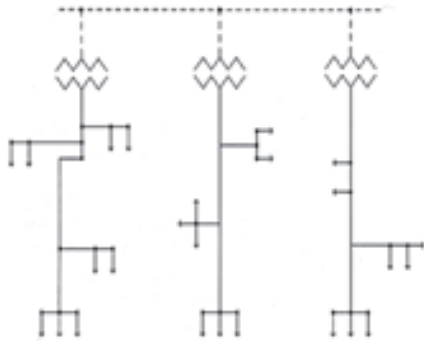
## 1.3 Underground Distribution

Nowhere in the distribution of electric power are the problems of installing, connecting and protecting conductors and equipment as complex as in underground systems. The underground environment is often unpredictable in temperature variation, flooding, and long-term growth of the system. Access to conductors and equipment is limited at best, and in many cases not possible. It is for this reason devices used in underground distribution systems are specially designed for ease of installation, compactness, and able to be completely insulated.

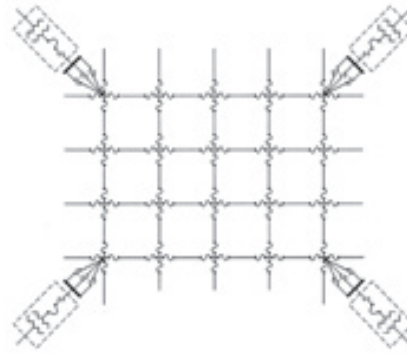
There are generally two types of underground distribution systems; radial (Figure 1.3-1) and network (Figure 1.3-2). The radial system is analogous to a wheel with spokes emanating out from the center. Main power is delivered to a central point, and from there is divided on series branch circuits to supply services to individual customers. The network system is much like a parallel grid and is described in section 1.3.2. Due to its

reliability, it has become the standard for underground distribution systems where load density is high (e.g. a city).

Over time, improved methods have been developed to reduce the cost of installation and maintenance for each of these underground systems.



**Figure 1.3-1 Radial Network**



**Figure 1.3-2 Secondary Network**

### 1.3.1 Design Objectives

While specific types of equipment designs meet particular service requirements, all have several basic objectives in common.

**Reliability:** Underground networks are designed to serve high load density areas. As a result, an uncontrolled failure in one area could affect the service to many customers. The need for reliability becomes obvious.

**Installation:** Working on underground networks means working in confined spaces, such as manholes and transformer vaults. Devices made for underground networks must be simple to install within minimal spaces.

**Economy:** By simplifying installation and maximizing reliability, devices used for underground systems become economical.

**Versatility:** Always remember that, like other distribution circuits, underground networks continually change and expand. Devices used in underground networks must allow for easy modification so that the present network can be adapted to future needs.

**Safety:** This must be a consideration in all design objectives! Safety in design includes providing for design tolerances that make installation easy and relatively error free, and allow for operation under non-ideal conditions.

### 1.3.2 Underground Secondary Networks

Underground secondary networks (see Figure 1.3-2) provide a means to distribute electric service to customers in congested areas. In the network, more than one transformer supplies the secondary feeds. When placed in parallel, the secondary feeders form a grid in which the end customer receives service, in essence, from more than one source. Each crossing point of the grid typically requires one, or more, junction connections with appropriate circuit protection. This arrangement provides the reliable service for which underground networks are noted.



The whole underground network starts with the primary feeders and switches. Voltages are stepped down for distribution by the network transformers, which are protected by relays and backed up by network protectors. The secondary cables (primarily copper) feed into the secondary network through connector banks, and are typically protected by limiters. At various locations within the network, service cables tap off the secondary cables to provide individual services.

Smaller versions of underground networks, called “spot” networks, exist to service an individual concentrated load such as an office building. Although not as expansive, the spot network has the same components as the underground network described above.

### 1.3.3 Special Considerations

Underground cables, connections and equipment are subject to continual or sporadic high moisture conditions. It is, therefore, necessary for all underground system components to be completely watertight, yet be capable of maintaining their long-term mechanical, electrical, and dielectric properties. When moisture is not of concern, such as in a ground level vault, the watertight properties are not necessary. However, watertight covering should still be considered if there is a reasonable chance of flooding or the occurrence of high humidity conditions.

### 1.3.4 Network Protection

Due to the limited access of underground cable, faults on underground systems pose a threat to system safety and long term reliability if not properly protected. Therefore, the main purpose of network protection devices is to protect the weakest link in the system, the cable insulation.

Network protection devices, commonly known as limiters, interrupt fault conditions while allowing temporary overload situations to occur. The two types of faults cleared by limiters are sustained faults (fault conductors solidly in contact causing high current flow) and arcing faults (intermittent contact causing a “slow roast” of conductor insulation). Temporary overload conditions are expected on networks and limiter time-current characteristics are appropriately designed to prevent nuisance blowing.

Normal system protection design methods should be followed for coordinating the limiters with other circuit protection devices, including circuit relays, fuses, and breakers. Appropriate locations must also be selected for network protection to localize the fault and prevent unnecessary outages.

Limiters protect a variety of copper cable insulation types. Table 1.3-1 provides a listing of some of the most common underground cable types protected by limiters.

<b>Limiter Protected Cable Types</b>	
Table 1.3-1	
<u><b>Insulation</b></u>	<u><b>Jacket</b></u>
Mineral base rubber compound or poly	Lead-sheath
Mineral base rubber compound or poly	Non-lead ed braid covered
Mineral base rubber compound or poly	Non-lead ed neoprene
Paper insulated	Lead-sheath
Varnish cambric	Lead-sheath

## 1.4 Overhead

Transmission voltages are stepped down at the substation for local distribution. Each substation supplies its locality through distribution feeders operating at voltages from 2.4 kV up to as much as 64 kV. Pole transformers in the overhead network step down the distribution voltages to 120/240 V for the secondary feeds to the customers.

Selection of connectors for use on overhead applications is dependent on, the type of conductor being used (aluminum, aluminum conductor steel reinforced (ACSR), copper, etc.), operating voltages, environmental conditions, whether the system remains energized or not, and the means of access (pole, ladder, bucket, etc.).

A good electrical connection requires three basic elements: the proper connector, suitable cable preparation, and correct installation procedures. In addition, field related conditions such as temperature, environment, and condition of the conductor are not controllable and will obstruct attempts at producing a suitable electrical connection. Therefore, the connector design must be able to compensate for these varying field conditions.

### 1.4.1 Thermal Expansion and Contraction

Normal operating conditions in overhead distribution will include periods of high load. Under these conditions, it is reasonable to assume a conductor can reach operating temperatures in excess of 150°F (66°C). At this temperature, an aluminum conductor mechanically loaded under 18 000 lb/in<sup>2</sup> will move approximately 0.01 inches per inch per hour. A copper conductor under similar conditions will creep only 0.000003 inches per inch per hour.

Therefore, when designing and selecting connectors for aluminum conductor, the contact area must be large in order to minimize the applied pressure and reduce creep. Lower mechanical loading will keep the creep rate under control.

When connecting dissimilar metals, the different expansion rates must be taken into account. Deep cup Belleville (conical spring) washers are used in mechanical connections to maintain force between the mating surfaces over wide operating temperature variations. Clamp type connectors for tap connections employ appreciably longer contact areas than that of standard compression connectors, thereby minimizing the effect of creep in both the conductor and the connector. Copper compression connectors must never be used for connecting to aluminum conductor as the high expansion rate of aluminum compared to copper will eventually loosen the connection and cause a failure.

Copper conductors, as previously seen, have considerably less creep than aluminum conductors. Thus, when making connections to copper conductors, creep is generally not a concern. What is important to consider, however, is the I<sup>2</sup>R heat generation and the connection's ability to dissipate thermal energy. If high contact resistance results from low applied forces or alloy metals are used in the connector, then the connector must be made with adequate mass to dissipate the heat.

### 1.4.2 Mechanical Integrity

The key question to mechanical integrity is how secure must a connection be? Once again, the application will guide us to the answer. For example, in the overhead distribution system, connections will require a full range of mechanical secureness; from full tension applications (95% of the ASTM rated breaking strength of the conductor) to strain relieved applications where little mechanical stress or vibration will occur.

Pullout tests and secureness tests are used to determine the adequacy of a connector's mechanical integrity. Pullout testing is used to establish the connector's minimum performance level for overhead lines in tension. Secureness tests involve rotating a hanging weight from the conductor held by the connector to simulate mechanical disturbances. Vibration testing is also necessary for checking for metal fatigue over the spectrum of oscillations anticipated in service.

An additional requirement for mechanical connectors is the ability to withstand approximately 50% more than the recommended torque. Mechanical connectors are tested in this manner to account for error in installation.

### **1.4.3 Dielectric Fundamentals**

High voltage connector applications require special considerations due to high voltage stress concentrations. Sharp edges and non-smooth conductive surfaces produce concentrated voltage gradients that can become sources of corona (ionization of air due to voltage stress). Connectors for high voltage applications are available in uninsulated and preinsulated forms. Uninsulated connectors for high voltage applications are designed with smooth, tapered surfaces. The smooth design reduces the likelihood of voltage stress and facilitates the use of semi-conductive tape to further reduce voltage stress. Field covering may also be used for dielectric insulation or as a shield in preventing excessive voltage stresses. Insulated, high-voltage connectors are designed to minimize corona that deteriorates insulation.

### **1.4.4 Corrosion**

There are two general types of corrosion that are of concern in overhead distribution connections. Oxidation and galvanic corrosion affect both the initial contact and the long-term performance of an electrical connection.

Oxidation can develop on both the connector and the conductor to be joined. Copper oxide forms on copper and copper alloy surfaces and is low in conductivity. Evidence of copper oxide can be seen as a black or green surface discoloration. Copper oxide layers will reduce the number of contacting points in a connection, thus increasing the contact resistance. The conductors should be cleaned prior to making a connection.

Aluminum oxide, however, is a fast forming, hard, non-conductive coating that develops on the surface of aluminum conductors exposed to air. Unlike copper oxides, aluminum oxide is not visually obvious and should be assumed to exist in all cases of bare aluminum. Aluminum oxide must be removed from a conductor's surface prior to making a connection. Wire brushing and the immediate application of an oxide inhibitor are recommended to prevent the reformation of the non-conductive coating prior to connector installation. (See section 3.1.1.1 Contact Surface Preparation for further details on preparing conductor surfaces for connection.) An alternate method that is used to achieve low contact resistance is for the connection methodology to physically break through the aluminum oxide layer as the connection is being made. Even with these types of connections, however, cleaning is still recommended prior to installation.

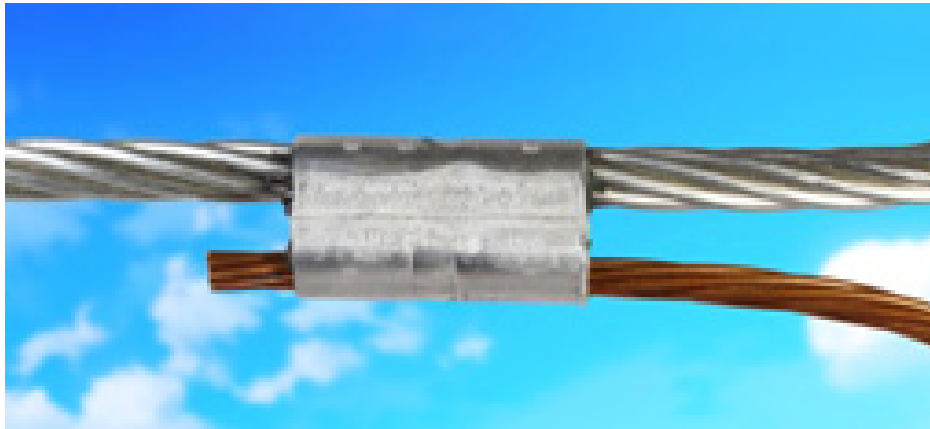
An additional problem with aluminum cable is the oxide layers that develop on each inner strand of a cable. These layers can cause high inter-strand resistance and are not easily removed. This problem is accentuated in compact conductor that restricts the movement of the strands during the application of force applied during connector installation. In these cases, the use of a contact aid with particle additives helps in breaking through inter-strand oxidation layers and in establishing the required contact spots.

The major cause of long term, overhead connector deterioration is galvanic corrosion. (See section 1.1.1 Corrosion, for further details on the principles of galvanic corrosion.) Both aluminum and copper conductors are used in the overhead distribution system. This use of dissimilar metals can lead to problems of galvanic corrosion if no preventive action is taken. Aluminum is the anode in the galvanic cell that is formed when in contact with copper, and is therefore the material that undergoes the corrosion. For applications that bring

aluminum into direct contact with copper, the aluminum is intentionally made to be massive in comparison to the copper. This “mass anode” principle relies on the creation of many paths of corrosion such that the corrosive current flow is minimized and insignificant amounts of the connector body are sacrificed over time.

Plating of aluminum connectors has been used to reduce the potential of the galvanic cell when applied to copper. In order to tin plate an aluminum connector, however, a copper or nickel flash must be applied first. If a scratch were to occur to the plating, a concentrated region of galvanic corrosion will develop and can result in deep pitting of the connector. This pitting may eventually lead to a failure in mechanical integrity of the connector. Due to the likelihood of concentrated corrosion to occur in this manner, and the added expense, tin plated aluminum connectors are usually not recommended for overhead applications. Plating of the cathodic material, in reverse, can be used effectively to prevent galvanic corrosion.

Finally, aluminum conductors should be installed above copper conductors. Moisture forming on copper conductors (rain or condensation) will pick up copper ions. If this moisture then drops onto aluminum conductors below, the copper salts will cause the aluminum conductor to corrode.



**Figure 1.4-1 Aluminum above Copper when outdoors**

### **1.4.5 Performance Testing (ANSI C119.4)**

Initially developed under the direction of the Edison Electric Institute (EEI) in 1958, the ANSI C119.4 standard has evolved through experience and extensive trials into its present day form. Now, a committee comprised of representatives of government agencies and electrical associations, electrical utilities and manufacturers, and supported by the National Electrical Manufacturers Association (NEMA) under the umbrella of the American National Standards Institute (ANSI), it continues to review and update this standard to relate it to technological innovations, modern test technology and requirements.

ANSI C119.4 specifies current cycle and mechanical tests for establishing a basis of performance for electrical connectors used to join aluminum-to-aluminum or aluminum-to-copper bare overhead conductors. As a connector tested on bare cable is a more stringent test, this standard is also used to test electrical connectors that will be jacketed and covered. The standard provides well-defined, reproducible requirements for electrical connectors and assures the user that connectors meeting these requirements will perform in a satisfactory manner when properly installed.

Current cycle testing consists of a current-ON and a current-OFF period; heating and cooling the test assembly. Cycle testing accelerates both oxidation within a connection as well as degradation due to thermal expansion and contraction. Resistance and temperature measurements taken at specified intervals provide the pass/fail criteria of the test. (For the four classes of current cycle tests, see Table 1.4-1) Mechanical

testing consists of pullout strength tests to compare the connector's results with the rated conductor strength according to the applicable ASTM conductor standards. Four classifications result from the mechanical testing, as shown in Table 1.4-2.

Table 1.4-1 ANSI C119.4 Current Cycle Classes		
Class (assists with selection based on anticipated line load)	Current Cycles	
	Control Conductor Temperature Rise	
	175°C	100°C
<b>AA</b> (extra heavy duty)	500	—
<b>A</b> (heavy duty)	—	500
<b>B</b> (medium duty)	—	250
<b>C</b> (light duty)	—	125

Reference the latest revision of ANSI C119.4 for actual test values and requirements.

Table 1.4-2 ANSI C119.4 Tension Classes	
Class (assists with selection based on anticipated mechanical requirements)	Percentage of Rated Conductor Strength
<b>1</b> (full tension)	95%
<b>1A</b> (normal tension)	60%
<b>2</b> (partial tension)	40%
<b>3</b> (minimum tension)	5%

Reference the latest revision of ANSI C119.4 for actual test values and requirements.

## 1.5 Service Entrance

The point where low-voltage lines, or services, connect the secondary main conductors to the customer's building is called the service entrance. Services may be either overhead or underground and usually depend on the type of distribution system from which they originate. However, underground services are frequently installed even from an overhead secondary main in order to eliminate aerial wires from crossing the customer's property.

The size of the service wire used is determined by the size of the anticipated electrical load. Underground services require large enough conductors to avoid replacement if the customer's load increases. Overhead services can be matched to the customer's present needs as they are readily accessible for replacement, and close matching reduces the initial investment.

### 1.5.1 Secondary Conductor

Economy and appearance dictate the use of several separate wires twisted into a cable for use as secondary mains and for service connections to buildings. These twisted wires, called "triplex," consist of two insulated phase wires and a bare, uninsulated neutral conductor that may also act as the supporting wire for the bundle. The twisted combination is strung from pole-to-pole as a secondary main or from pole-to-building as a service drop connection. Other bundle combinations exist; for example two wire bundles (duplex), and four



wire bundles (quadruplex). The individual wires are usually aluminum or ACSR, sized from #6 AWG to as large as 336.4 kcmil depending on service requirements.

## **1.5.2 Service Connectors**

Service entrance applications require a relatively small number of connector types. The connectors most often required are mechanical, wedge and compression splices and parallel taps, which are available insulated and uninsulated.

When connecting insulated conductors, only insulated splices and taps should be used. Insulated connectors are designed to seal out contaminants and moisture to minimize the effects of galvanic corrosion. When connecting to the uninsulated neutral conductor, however, only uninsulated connectors should be used. The absence of insulation on the neutral wire prevents an insulated connector from fully sealing out moisture. Premature failure can result from corrosion as a direct result of captured moisture within the connector's insulation.

Covers are often provided for service connectors and should not be confused with insulation. Covers are intended to protect against brush contact, and normally will have holes to allow moisture to drain, preventing premature failure due to corrosion.

Regardless of the type of connector used, one of the most important features of the service connector is easy installation. In many cases, the installer will be on a ladder and/or in an awkward situation. Ease of installation reduces the chance of injury by minimizing time spent in a precarious position. In the case of the service compression splice, specific mechanical compression tools are available to assist the installer with the connection installation. New battery powered tool technology can further ease the installation for a reliable connection.

## **1.6 Telecommunication**

The telecommunications industry today encompasses more than the simple telephone. The vast array of cellular technology, along with the integration of computer processing for all types of electronic communications and data, creates many specialized connection needs. On top of the technology integration within this industry is the shift from its humble beginnings of being seen as a luxury item to today's view of communications as being a necessity. Our modern way of life has become increasingly dependent on our ability to communicate across town, and around the globe. As a result, there is high emphasis placed on the reliability of the telecommunications network, even in the midst of disasters that affect other infrastructure.

### **1.6.1 Telecommunication Conductors**

Conductors used in the telecommunications industry vary widely depending where in the system they are being used. Cellular sites, for example, will have a mix of needs from the more traditional copper grounding conductors, to the more specific large-size flex conductors often visibly seen running down the length of the antenna structure. Within central offices vast arrays of power-delivery conductors handle the needs for the equipment during normal operation and, in the event of power outage when battery backup (UPS) systems are depended upon, to keep communication services operating. The ground system within these facilities is also highly developed to suppress noise on low-voltage communication lines and ensure signal integrity.

### **1.6.2 Telecommunication Connections**

Connectors (and accessories) used in the telecommunications industry are developed for the many specific needs that arise due to conductor types and applications. Large flex-stranded copper conductors with many branch circuits have lead to an array of tap connectors that allow for many variations. Raised floor pedestals

come in various geometries and with non-conductive coatings, thus creating challenges for bonding to the ground system.

In all cases, due to the high reliability required of communications systems, connections must have a means for inspecting for proper installation. Die embossments for compression connections (Figure 1.6 1), matched tooling specifically tested with the connection/conductor combination, and clear covers allowing the performance of visual inspections have all been developed and specified to maintain a high level of installation quality and resulting reliability.



**Figure 1.6-1 Imprinted Logo & Die Index Number on Terminal**

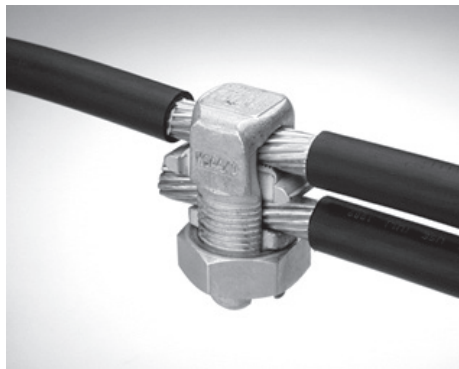
## **2.0 CONNECTOR FUNCTIONS AND TYPES**

### **2.1 Functions**

The three fundamental connector functions are tap, terminal, and splice. In order to categorize connectors based on function, a clear understanding of these terms is necessary. The definitions and examples that follow will begin to differentiate the three main functions.

#### **2.1.1 Tap**

Electrical tap: an electrical connection to a main or continuous-run conductor to supply electrical energy to a branch application(s) from the main run's principal load. Figure 2.1-1 illustrates a tap configuration.

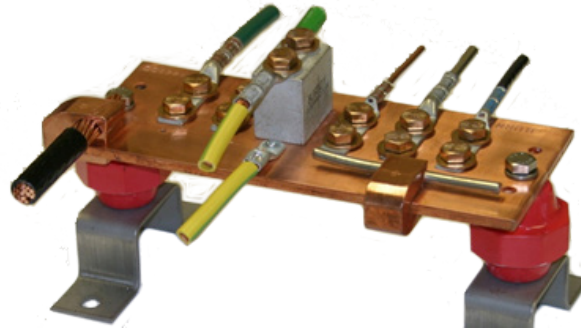


**Figure 2.1-1 A Mechanical Tap Connection**



## 2.1.2 Terminal

Electrical terminal: a connection used to join two different forms of conductor, often incorporating more than one means of connection methodology e.g. joining cables to a bus bar as shown in Figure 2.1 2.



**Figure 2.1-2 Variety of Terminal Connections**

## 2.1.3 Splice

Electrical splice: a connection that joins two (or more) similar but non-continuous conductors into one continuous run; or that joins together two unconnected continuous runs. Figure 2.1-3 depicts several typical splice configurations.



**Figure 2.1-3 Copper (left) and Aluminum (right) Splice Connectors**

## 2.2 Types of Connectors

The types of connectors developed over many years generally fall into three broad categories: mechanical, compression, and fusion. Mechanical connections employ hardware or similar mechanical means to create contact points and to maintain the connection integrity. Compression connections use engineered tooling to crimp the connector to the conductor with high force, creating a permanent electrical joint. Implosive connections are made by detonating a charge to compress connector to cable. Fusion connections are made primarily by welding, soldering or brazing. The following sections cover the properties of each of these connector design categories, or specific connections contained therein.

### 2.2.1 Mechanical Connectors

Basic contact theory (see 1.0 THEORY OF CONNECTOR TECHNOLOGY) describes how electrical contact is established between conductors by the application of mechanical force. Even when the applied force is low, the resistance at a contact point is, in theory, zero (in practice, resistance is extremely low; typically in the micro-ohm range or lower).

However, there are many factors other than contact resistance to consider.

The mechanical connectors developed over the past few decades overcome many of the installation complications ascribed to fusion connection methods, such as soldering and welding. Today's mechanical connection is designed to accommodate the current carrying capacity of the conductor and provide ease of installation, resulting in a safe, reliable electrical connection especially when installed at the manufacturer's recommended torque.

### **2.2.1.1 Connector Material**

Generally the alloy and hardware used for a mechanical connector depends on whether the connector is for a strain or current carrying application, and if the intended conductor is aluminum, copper, or other materials. Particular alloys and hardware are selected for strength, conductivity, durability, ductility, and resistance to corrosion.

In a mechanical copper connector, high strength alloys are used for clamping elements, and high conductivity alloys for current carrying parts. A popular choice for mechanical, copper-alloy connector hardware is silicon bronze (DURIUM™) due to its high strength and resistance to corrosion.

Mechanical aluminum connectors must be made from alloys impervious to stress corrosion. In their heat treated state, aluminum alloys have high strength and may be used for both current carrying and clamping elements. Anodized aluminum alloy bolts are usually used for mechanical aluminum connectors. Bolts made from these alloys provide the best combination of strength and resistance to galling and corrosion. In addition, their thermal coefficient of expansion is most suitable for aluminum.

### **2.2.1.2 The Clamping Element**

The clamping element of a mechanical connector provides the mechanical strength, as well as the current paths, of the connection. The following general rules are basic to the design of the clamping element, regardless of material used for construction:

1. Minimize conductor distortion and abrasion in order to prevent conductor fatigue (especially in applications where vibration or stress concentrations are present). Screws that apply direct pressure to the conductor are not advised. Connectors that use direct pressure screws must be designed to minimize distortion or damage to the conductor. If a compact connector requires a single bolt to accommodate the conductor, a pressure bar is recommended unless the connector is used in a light duty application.
2. The National Electric Manufacturers Association (NEMA) has adopted suggested standards to guide mechanical connector design. NEMA differentiates between classes in terms of the minimum number and size of bolts. The size of the bolt is determined by the clamping pressure needed to drop the resistance to a value low enough to provide a highly conductive, stable joint. The bolts used in mechanical connectors are not only the means of fastening parts of the connectors together, but more important; they are also the means of establishing contact points along the connector and conductor surfaces.

Stainless steel bolts are recommended for application in highly corrosive environments and must be used in conjunction with proper selection of the connector.

The addition of Belleville spring washers is generally recommended in place of flat washers when using different connection material combinations. Belleville washers enhance the connection resilience to different thermal expansion and contraction rates (aluminum has twice the coefficient of expansion as steel!). Note, however, that Belleville washers cannot completely compensate for inadequate contact area, incorrect torque, or poor design. (See section 3.1.1.4 Hardware, for specific recommendations.)

3. Place the bolts as close to the conductor as possible to reduce the effective length of the moment arm. Reduction in moment reduces stress within the connector. High internal stress can lead to cracking or other damage and will thus require larger connector elements than is otherwise necessary.
4. Accessibility with one wrench installation and suitable wrench clearance. Mechanical connectors often allow for one wrench installation to facilitate hot-line work and to simplify the installation process. In addition, bolt heads are all placed on the same side of the connector to allow for accessibility. Installation at the manufacturer's recommended torque is critical to the longevity of these products.
5. Employ sufficient wrap-around to contact all conductor outer strands. Establishing contact with all of the outer strands of a conductor is essential for current equalization and overall thermal performance.
6. Employ material in a manner that will make best use of its properties. The clamping element design should resist penetration of galvanic or atmospheric corrosion. Also, when considering copper mechanical connectors, thinner sections are possible because the material will yield to form around the conductor, and thereby shortening the moment arm and reducing stress. However, an aluminum mechanical connector must have a sufficient cross section to prevent deflection due to lack of conformance and brittleness inherent in the material.

### 2.2.1.3 Advantages of Mechanical Connectors



**Figure 2.2-1 A Mechanical Tap or Splice Connector**

Mechanical connectors (an example is shown in Figure 2.2-1) generally have an advantage over other types of connectors (e.g. compression) in the degree of inherent resilience of the connector components. Resilience permits follow-up of creep and reduces the stresses due to thermal expansion that tend to cause excessive creep. The components of a properly designed mechanical connector supply the desired resilience.

Mechanical connectors should also be installable with basic tools, i.e. socket or open end wrenches, screwdrivers, etc. These connectors are simple to use and often require minimal training to be installed properly. Physical exertion is typically not excessive, although installing many connectors and/or clamping hardware per connector can require some endurance. Mechanical connectors also have the advantage of being removable, and may be reusable if in good condition (check with the manufacturer for their recommendations on reuse). When conditions warrant, mechanical connectors disassemble without damage to the connection components.

Electrical performance of mechanical connectors meets or exceeds the industry requirements for which they are designed. Hence, performance is not compromised when using mechanical connectors in tested applications.

### 2.2.1.4 Disadvantages of Mechanical Connectors

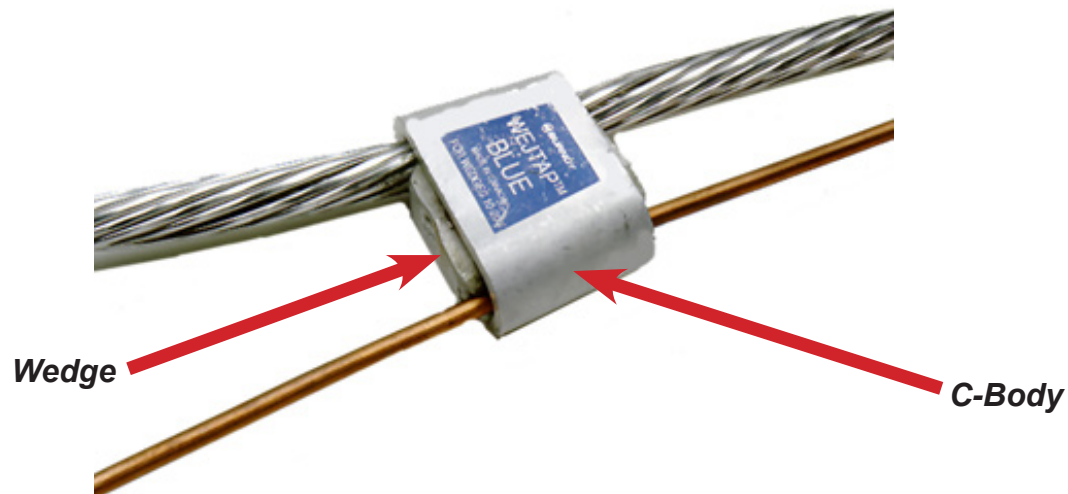
Although mechanical connectors offer versatility and ease of installation, among other attributes, there are some drawbacks and concerns that must be addressed.

Specific torque requirements must be followed to provide the proper clamping force needed for a sound electrical connection. Installers rarely use calibrated torque wrenches to tighten the nuts and bolts on mechanical connectors. Thus, the consistency of forces applied over identical mechanical installations is not generally repeatable.

The general nature of a mechanical connection does not allow for high mechanical holding strength. Hence, mechanical connectors are not used as full tension connections. Similarly, the use of mechanical connectors in areas of high vibration may require more maintenance and periodic inspection. Finally, if an insulated connection is required, mechanical connectors are usually difficult and awkward to adequately cover due to their geometry.

## 2.2.2 Wedge

Wedge connectors are in actuality a unique category of mechanical connectors, and sufficiently distinct enough to address separately. The wedge connector incorporates a wedge component and a tapered, C-shaped spring body (or C-body). During installation the wedge is driven between two conductors into the 'C,' spreading the C-body which in turn places high forces on the conductors for a reliable, stable connection. (See Figure 2.2-2).



**Figure 2.2-2 Wedge Connector Components**

There are three means by which the wedge is driven into the 'C' member: (a) a specially designed tool system where a cartridge is discharged to propel the wedge between the cables at high velocity (powder actuated) (b) a mechanical tool that pushes the wedge at low velocity between the conductors, and (c) a mechanical drive bolt which, when tightened, drives the wedge between the cables. (Refer to Section 3.1.2 Wedge Installation, for further details.)

The wedge connector is primarily used in tap applications, although other functions are possible. Wedge connectors are capable of joining combinations of aluminum, copper, and ACSR conductors.

### 2.2.2.1 Advantages of Wedge Connectors

Powder actuated wedge connectors provide consistent, uniform performance. Repeatable installation forces from one connection to the next are assured by selecting the proper booster. The rapid mechanical wiping action as the wedge is driven between the conductors breaks down surface oxides and generates superior contact points which together reduce overall contact resistance.

Powder actuated wedge connectors are installed with lightweight, portable tools that feature simplified loading and engaging mechanisms in order to speed up the installation process (especially when compared

to manual hydraulic crimping tools). The powder actuated system requires low physical exertion from an operator to complete a connection. (Mechanical wedge connections are installed with a basic wrench, requiring more physical exertion for installation.)

The spring effect of the 'C' body (especially on the powder actuated types) maintains constant pressure throughout the life of the connection for reliability under severe load and climatic conditions. Constructed with a large mass, wedge connectors dissipate heat well and utilize the mass-anode principle to reduce the effects of galvanic corrosion.

Finally, the electrical performance of fired-on wedge connectors has been shown to be excellent. The large mass, along with the low contact resistance developed during installation, result in a connection that meets the ANSI C119.4 standard mechanical and electrical test requirements.

### 2.2.2.2 Disadvantages of Wedge Connectors

Although powder actuated wedge connections provide numerous benefits, it is a dedicated system requiring full support from the user on training, maintenance, and service. Precautions are required to ensure a safe and proper installation. Installers must be provided with special training and personal protective equipment in order to be qualified for installing wedge connections.

Mechanical wedge connectors installed with wrenches exhibit more inconsistent performance than their powder actuated cousins. Discrepancies in the mechanical installation process are caused by contaminants on the hardware and wide tolerances of shear/breakaway head bolts. Further, mechanical wedge spring bodies are typically manufactured by casting which produces much less spring action to maintain the connection.

All wedge connections are restricted to non-tension, outdoor applications. For example, no in-line splice connection is available in a wedge configuration. Other connection methods are still needed for complete coverage of all potential applications.

Each wedge connector is suited only for a limited range of conductors. Conductor size must be carefully matched to the wedge connector to guarantee an appropriate connection. And, although special covers are available for contact protection, the wedge connector geometry makes full insulation difficult.

### 2.2.3 Automatic Connectors

Automatic line connectors are a unique subset of mechanical connectors (Figure 2.2-3). Automatics provide a permanent butt splice connection in spans where the installed tension exceeds 15 percent of the rated breaking strength of the conductor. These connectors are used almost exclusively in distribution applications and are one of the fastest methods of splicing two overhead conductors.

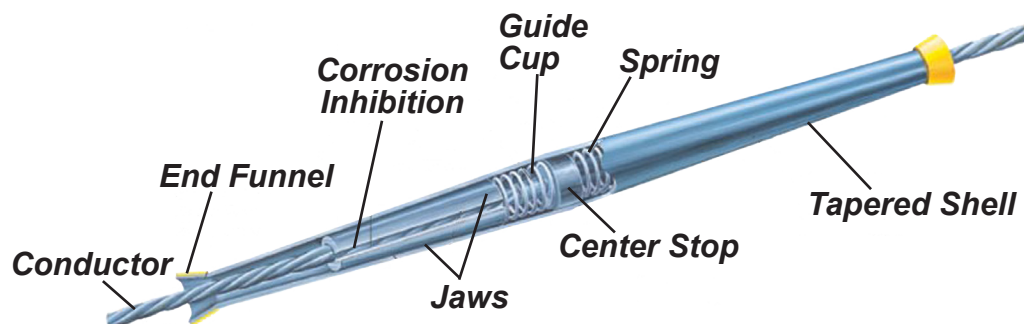


Figure 2.2-3 Automatic Splice



The “automatic” principle utilizes tapered serrated jaws inside the connector sleeve which grip the conductor when tension is applied. When an attempt is made to withdraw the conductor, the jaws clamp down further on the conductor due to the taper in the connector. This wedge action increases with the pull applied to the conductor. Obviously, automatic connections must be used only where the wires are maintained in tension. These splice connectors, as well as dead-ends, are made from aluminum, copper, and steel alloys for use on aluminum, ACSR, copper and steel conductors.

### 2.2.3.1 Advantages of Automatic Connectors

The primary advantage of automatic connectors is their ease of installation. No tools other than a wire brush are necessary to make an effective installation, and the skill level required is minimal. As a result of the simple installation, the installed cost of automatics is kept low.

Automatic connections also comply with ANSI specifications for performance and are rated for full-tension applications.

### 2.2.3.2 Disadvantages of Automatic Connectors

The major disadvantage to automatic connections is their limited application. As they depend on tension (a minimum of 15% of the conductor’s rated breaking strength) they can only be used in suspension applications for splicing. Consequently, these connectors would not be applicable for tap, jumper and other non-tension applications.

Although the actual installation is relatively simple, care must be taken to properly prepare the conductor for the resulting connection. Cable ends must be squared and surfaces thoroughly cleaned by wire brushing prior to installation. These connectors are also extremely sensitive to dirt and other contaminants getting into the contact area, even after installation.

As discussed in section 1 and shown in Fig. 3.1-2, electrical resistance will vary with contact force (pressure). For automatic connectors, this fact becomes very important. It is critical that constant tension is maintained on automatic connections. Line sag and wind vibration may adversely affect contact resistance, and ultimately the integrity of the connection, over time.

## 2.2.4 Insulation Piercing Connectors (IPC)



**Figure 2.2-4** *Installing an Insulation Piercing Connector*

Insulation piercing connectors are another particular subset of mechanical connectors. These connectors are designed for indoor and outdoor non-tension tap and splice applications on insulated secondary distribution lines. IPCs are recommended for use on combinations of insulated copper and aluminum conductors. An example of a tap installation is shown in Figure 2.2-4 but the connector can also be used as a low tension splice. Often, these connectors come with torque limiting devices (i.e. shear/breakaway head bolt) and when they don’t, a torque wrench should be used to install it.

### 2.2.4.1 Advantages of Insulation Piercing Connectors

Insulation piercing connectors (IPC) are designed with lower installation costs in mind. No special tooling is required as they are wrench installed. When joining insulated conductors (their principal use), no insulation stripping or application of oxide inhibitor is required making the

connection much simpler. IPCs incorporate contact teeth designed to penetrate conductor insulation, make electrical contact, are angled so that the insulation fits snugly around them, and are pre-filled with an oxide inhibiting compound to fill voids preventing contamination. Many IPCs come with shear head bolts negating the need to monitor the installation torque with a torque wrench.

Insulation piercing connectors are themselves insulated, thus, no tape or special cover is required after making the connection. Installations on energized conductors can be easily made and are relatively safe.

### 2.2.4.2 Disadvantages of Insulation Piercing Connectors

Insulation piercing connectors are limited in their scope of application. Specifically, they are recommended for low voltage (600 V and below) secondary distribution applications where insulated conductors are employed. The nature of the connection device limits these connectors to function mainly as taps, although some parallel splices can also be made. IPCs are for use in non-tension applications only.

With the many forms of conductors and insulation materials that are available today, always check the connector specifications for compatibility with the conductors being joined. IPCs may not be suitable for conductors with very thick, very thin, or very hard insulation materials as they could damage the conductor or not make electrical contact at all. Never use an IPC on bare conductor.

### 2.2.5 Compression Connectors

Compression connectors are part of a connection system that utilizes specific installation tools and dies for installing permanent, high quality connections. The versatility of a compression system ensures that all connector functions (tap, terminal, and splice) are attainable in numerous forms. In addition, compression connectors are available for aluminum, copper and steel conductors and combinations thereof. An example of the bits and pieces needed to make a compression termination is shown in Figure 2.2-5.



**Figure 2.2-5 Components needed to make a compression installation**



### **2.2.5.1 Advantages of Compression Connectors**

The low cost of a compression connection compared to other methods cannot be overlooked, particularly where distribution is concerned. Performance wise, compression connectors will normally operate better than mechanical connectors, and at worse, just as well. The nature of their construction allows for a better degree of conductor encirclement that retains the oxide inhibiting compound and protects the contact area from the atmosphere, thereby providing a maintenance free connection.

The focused, consistent forces imparted in a compression connector by the installation tool results in an electrically and mechanically sound connection. High forces break down the oxides and establish contact points (A-spots) for reduced contact resistance. The compression connector itself is made from a material that is soft relative to the conductor so that it minimizes spring back and reduces contact separation.

Requirements for full-tension applications are stated in ANSI C119.4 and, for the most part, are accommodated by compression connectors. Compression connectors are most suitable in areas of wind, vibration, ice build-up and other stresses associated with tension applications. Compression connections have also proven themselves in rigorous grounding applications above and below grade. Compression grounding connectors are available that withstand the rigors of UL467 and IEEE STD 837 testing.

A very important advantage for compression connectors is the removal of the human element during installation with the use of recommended tools and/or dies. Consistent and repeatable forces are imparted with each and every crimp. The compression system may have color coded dies to match the color coding on the connector. If color is not present, an index number is included with the stamped markings on the connector, and should match the die index number. Some dies will also emboss their index number on the completed crimp, resulting in a combination that is nearly foolproof for inspectability. To further simplify the compression process, dieless installation tools do not require die selection and insertion.

Due to their geometry, compression connectors are considerably easier to insulate or tape than mechanical connectors.

### **2.2.5.2 Disadvantages of Compression Connectors**

Although an installed compression connection is usually lower in cost than alternative connector types, obtaining the proper installation tooling for a compression system program involves potentially high capital investments.

In addition, there are many different types of compression tools to select from, making initial decisions difficult and costly if changes are made later to the program. Compression installation tools have developed over many years to accommodate many different customer requirements (i.e. conductor sizes or ease of handling). Hence, a typical compression splice connector could potentially have a multitude of tools and dies recommended for installation.

Due to the need for specific tools and dies to install a compression connection, installers must be trained on the proper techniques and maintenance of these tools. Accurate die and tool selection is a must for proper installation of a compression connection.

When using manual tools, it must be realized that some compression connections require greater physical exertion to install than others. When installing numerous connections, installers can become fatigued and possibly not complete or omit some of the specified number of crimps.



**Figure 2.2-6 Welded T Connection and Bus Supports**

## 2.2.6 Welded Connections

Welded connections are used primarily in substation applications, and particularly for aluminum conductors (Figure 2.2-6). Once the substation is designed, various connection interfaces will require a connection methodology to be selected. As covered earlier, in many cases a mechanical means will be chosen. However, welded connections provide a viable alternative for certain connections.

### 2.2.6.1 Advantages of Welded Connections

Welded connections can provide an economical means only when making many connections within a substation. Large quantities of connections results in lower costs per weld due to the availability of needed materials and skilled, qualified labor. A properly welded joint can create a continuous conductor that is highly reliable. Allowing for the conductivity of the filler material, the essentially homogenous union created by a weld provides a resistance ratio less than unity.

### 2.2.6.2 Disadvantages of Welded Connections

Welding is not a cost effective connection methodology when upgrading or making additions requiring a few connections. Low quantities of welded joints result in high installation costs.

Additionally, to produce a reliable weld requires a very highly skilled technician. The welding process requires the materials being joined to be free of all contaminants. Any surface impurities, such as grease or dirt, will contaminate the joint and result in low electrical conductivity and/or insufficient mechanical strength. Contaminants may also cause premature corrosion of the welded connection. Cleaning conductor surfaces may be adequately performed with solvents, but mechanical cleaning methods may also be necessary. As a consequence, installation costs may rise on account of the increased time needed to properly prepare the conductor and due to the high skill level of personnel needed to perform welding operations.

## 2.2.7 Exothermic Weld Connections

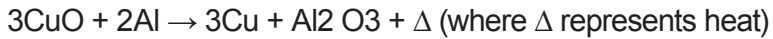
When two or more chemicals give off heat in the process of reacting with one another, it is called an exothermic reaction. A weld is defined as the process of joining materials (e.g. metal parts) by heating the surfaces to the point of melting. An exothermic weld is a process in which a chemical reaction is utilized to develop high heat sufficient to melt the materials to be joined.

The exothermic weld used for electrical connections utilizes a powdered mixture of copper oxide and aluminum. These materials are ignited at a low temperature, and the resulting high-temperature reaction melts the powdered materials to liquid form. The superheated-molten copper, contained and controlled within in a semi-permanent graphite mold (Fig. 2.2-7), flows around the conductors to be joined, causing them to melt. When cooled, the conductors are joined in a fusion weld.

The chemical reaction of the base materials is described by the following chemical equation:



**Figure 2.2-7 A graphite mold for exothermic welding. The reaction is initiated by igniting powder at the opening on the top of the mold.**



Exothermic connections have a wide range of applications in various industries, from its originations in the rail industry for making signal connections to steel rail, to lightning protection systems, cathodic protection systems, and grounding.

### **2.2.7.1 Advantages of Exothermic Weld Connections**

When installed properly, exothermic connections exhibit excellent electrical properties that are not affected by high-current surge. The resulting weld joint also protects the critical electrical contact surfaces between the materials joined, helping to reduce loss of electrical contact over time due to corrosion. They are also not subject to loosening due to vibration or other mechanical disturbance.

Similar to welded connections, the material costs of an exothermic connection can be relatively low when compared to other connection means.

### **2.2.7.2 Disadvantages of Exothermic Weld Connections**

As is the case with any welded connection, the materials being joined must be clean and free of contaminants that can interfere with the process. Visual inspection methods are possible; however, training on these methods is advised. In some locations, only resistance measurements are allowed for inspection purposes of exothermic connections.

The materials in the exothermic process reach temperatures in excess of 2000°C (3600°F). Hot molds are potential fire hazards, and are hazardous around volatile fumes. (Hot Work permits may be compulsory.) The intense heat also anneals conductors and damages insulation (if present). Due to the annealing of the conductor, exothermic connections are not to be used in tension applications.

The high temperature is also a potential safety hazard for personnel, who must wear proper personal protective equipment when installing these connections. Extreme caution is required during inclement weather to avoid causing steam within the mold from moisture contamination.

## **2.2.8 Split Solder Sleeves**

Split solder sleeves are used primarily for fusion type splices in the underground distribution network. These connectors simply provide a holding sleeve for inserting the conductors to be joined. Once inserted, the wall split along the entire length of the connector allows for wetting of the conductors during soldering.

### **2.2.8.1 Advantages of Split Solder Sleeves**

When installed properly, the split solder sleeve provides an excellent electrical connection. Open split solder sleeves have been developed recently to allow easier access of the solder to the conductors, eliminating the possibility of solder voids within the connector.

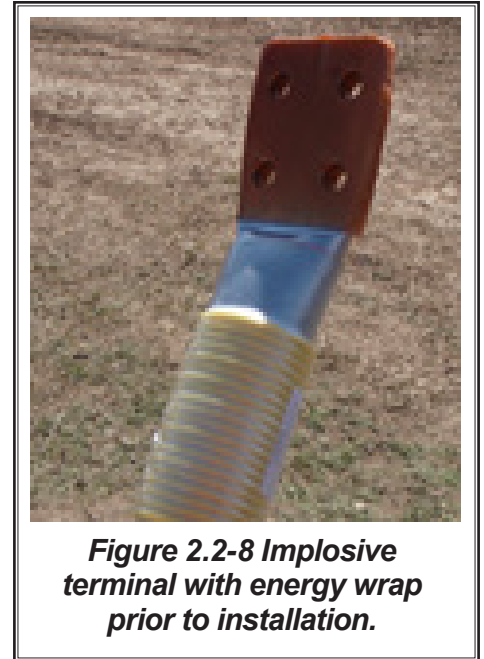
### **2.2.8.2 Disadvantages of Split Solder Sleeves**

The fabrication of a split solder joint requires a high level of training, high amounts of heat, and can lead to health risks. To form an acceptable solder joint, the conductors being joined must be preheated to allow wetting. When working with large conductors, heating entails the use of torches which may be unsafe in confined areas. Fluxes used to clean the conductor and the solder itself vaporizes during soldering and in the confines of underground installations, with prolonged exposure, can lead to solder asthma.

Further, solder materials will usually have low melting temperatures, especially, when compared to the conductor material. The reduced temperature capacity of the soldered connection, therefore, reduces the overall maximum operating temperature of the circuit. Significant consequences due to the lower operating temperature may affect how overloads and fault conditions are specified and handled.

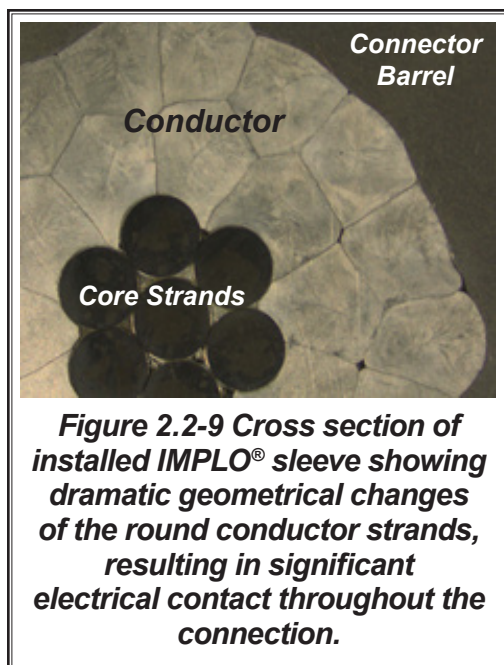
## 2.2.9 Implosive Connections

Implosive connectors (often referred to as IMPLO®) are a special class of compression connections with very unique properties that differentiate them from tool-installed compression connectors. Similar to compression connections, implosive connectors rely on the permanent deformation of the connector and conductor to create, and then maintain electrical contact. Also similar in geometry to tubular based compression connectors, implosive connectors are provided with a specialized energy wrap around the outer barrel (Fig 2.2-8). The wrap, when initiated during installation, applies an inward (thus implosive) compressive force to the entire surface of the connector. The compressive force applied is much greater than achieved by a hydraulic compression tool, and is practically instantaneous along the complete length of the wrap material. This installation process affects the connection materials, i.e. the connector and conductor, in a dramatic fashion yielding highly desirable connection characteristics.



**Figure 2.2-8 Implosive terminal with energy wrap prior to installation.**

### 2.2.9.1 Advantages of Implosive Connections



**Figure 2.2-9 Cross section of installed IMPLO® sleeve showing dramatic geometrical changes of the round conductor strands, resulting in significant electrical contact throughout the connection.**

The design of the implosive connector coupled with the installation process results in a vastly higher quality connection with capabilities not possible with traditional compression. The first objective of a connector is to create electrical contact. The implosive sleeve achieves this by tremendous disruption to the contact surfaces within the connector, and throughout the conductor stranding down to the core. Brittle aluminum oxides are shattered during installation opening up vast areas of true metal-to-metal contact. These areas are created throughout the entire cross section of the conductor, and locked into place by the rapid compression. As the materials are reshaped (Fig 2.2-9), air is squeezed out of the connection leaving little chance for the reformation of oxides in the future. It is important to note that the materials are only being reshaped and compressed during the implosion. All of the material, conductor and connector, remain in the connection area as there is no extrusion of materials. Thus, the initial connection is of high electrical conductivity, and the maintenance of the contact area over time is locked in by the strength of the reformed sleeve and high compression fill-to-void ratio. Due to the creation of high density of electrical contact and

locking out oxide growth, implosive sleeves will operate at elevated temperatures with little to no degradation.





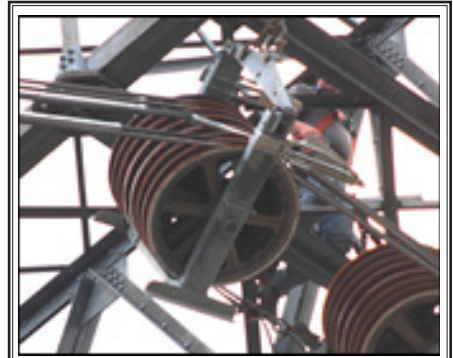
**Figure 2.2-10 Multiple IMPLO® deadends being installed simultaneously.**

The process of implosion, seen in Figure 2.2-10, also eliminates many field variables that have proven to be the cause of premature connection failure. Implosive sleeves provide clear external indicators to fully determine the quality of the connection, and do not utilize any oxide inhibitors.

As there is greater compressive force applied by the implosive process than hydraulic tooling, the connectors themselves may be manufactured with greater strength than their thinner walled counterparts. The greater barrel strength and specialized inner surface design allow implosive splices to be pulled through stringing blocks with no damage to the splice or the

conductor (see Figure 2.2-11). This allows connectors to be installed at ground level and pulled into place with the conductor eliminating staging areas between pulls and thus reducing the environmental footprint new projects and restringing operations entail.

Other advantages to the implosive process include no bowing of completed connections, no filing of sharp flash areas caused by compressive dies, and no bird caging of conductor strands at the mouth of the connection. These anomalies are often present to various degrees on tool-installed connectors depending on the installer's experience, connectors used, and conductor material.



**Figure 2.2-11 Six IMPLO® splices passing through a stringing block during construction of a 765kV transmission line.**



**Figure 2.2-12 Typical storage magazines for implosive connections.**

### 2.2.9.2 Disadvantages of Implosive Connections

The largest drawback to the implosive process is the noise generated during installation. Although mitigation techniques are possible, this remains the largest barrier to widespread usage of implosion on transmission and distribution systems, especially in populated areas.

Generally, savings on project costs can be significant when utilizing implosive connections. However, the implosive advantages are best realized with larger conductor sizes, typically with 4/0 AWG being the absolute smallest. Implosive connectors also have higher

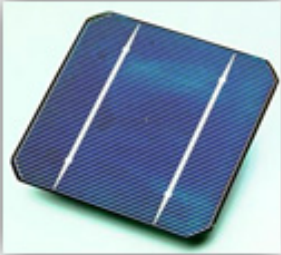
initial acquisition pricing due to more material content and the implosion material itself being prepackaged with the connectors. Thus, if initial cost is the only factor serving for connection selection, the implosive process could potentially be eliminated from consideration. It therefore becomes dependent on how a project is being specified, acquired, and constructed to realize the potential savings of implosive connections.

Also a consideration with implosive connectors is the shipping and storage. Special shipping requirements may be necessary as designations for explosives vary by country, and even possibly by state or province, with material, content, and packaging. Storage of implosive connectors will require a specialized container, or magazine, meeting the requirements of the material designation (one is shown in Figure 2.2-12).



## 2.2.10 Solar Electrical Panel Connections

Solar modules work via the photovoltaic (PV) effect (discovered in the 1880s) whereby light striking the sensitive material causes electrons to move creating a flow of current. The current is unidirectional (direct current) and the energy can be stored in a battery for use when needed.



**Figure 2.2-13 Example of a solar cell**

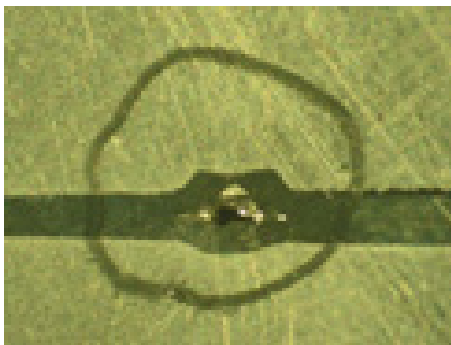
The modules are then connected in series and parallel depending on the needed voltage and current. Most solar electric systems are a combination of series-parallel circuits making up strings. Often, the modules are mounted on a metal rack orienting them at an optimum angle to the sun, depending on the location's latitude. Since many modules need to be connected, electrical connectors meeting industry standards are required to be used. As there is much non-current-carrying exposed metal, it must be bonded and grounded (earthed) in accordance with the National Electric Code to prevent electrical shock should it become energized.

Photovoltaic cells (Fig. 2.2-13) are usually made of silicon wafers or of either continuous or discontinuous film. The photovoltaic material is deposited on the substrate making either a silicon wafer or a film. To maintain flatness, the film or wafer is mounted on a supporting material thus making a cell. PV cells are then laid on another backing support and many cells are joined electrically making the beginnings of a module. To protect the cells from damage, a transparent cover (often glass) is used. This whole subassembly is then encased in a sealed frame (often aluminum) making the completed module (Fig. 2.2-14).



**Figure 2.2-14 A solar module or panel**

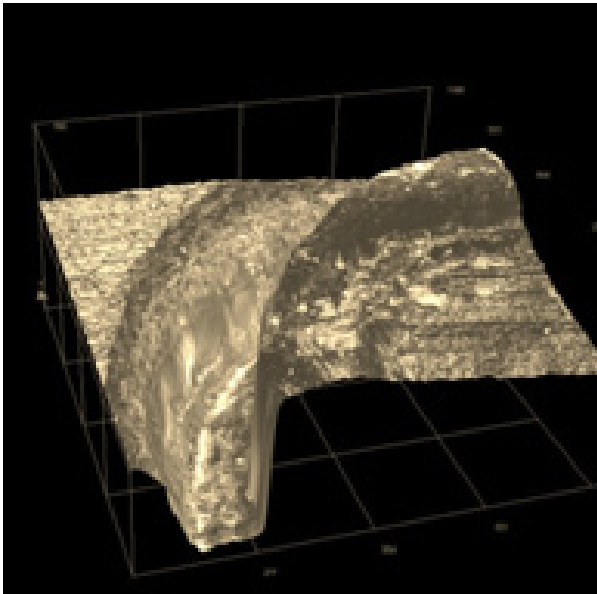
Prior to the invention of the WEEB® washers, modules were grounded and bonded together with many feet (or meters) of cable and a large number of connectors. Not only was this a time consuming and costly process, it also created potentially inductive loops in the equipment grounding conductor. With the WEEB® washer much of the copper cable has been eliminated by using the supporting structure as a conductor and greatly reducing the time to make electrical connections. Although the mounting structure mainly consists of steel or aluminum, there is more than enough metal to conduct electrical current to ground replacing much of the 6 AWG copper conductors that would have been used.



**Figure 2.2-15 Bonding washer embedded in Al matrix**

The principle of the WEEB® washers is that they are placed between two metallic surfaces, usually between the PV module frame or part of the rack and another part of the mounting system, which are often made of anodized aluminum. When tightening the nut or bolt to the prescribed torque, the WEEB® washer, being made of a corrosion resistant stainless steel and of a structurally strong geometry, is compressed into the metal parts. The clamping force from the fastener on the WEEB® washer causes very high compressive and shear stresses to develop, exceeding the strength of the anodized surface of the aluminum, piercing it (Fig. 2.2-15). The sharp edges of the WEEB® washer's teeth then penetrate beyond the anodized layer to become embedded into the underlying clean metal providing a low resistance electrical bond. Figure 2.2-16 shows how the metal was moved upon compression of the WEEB® washer. The metal to the right of the photo

has risen higher than the original surface to the upper left. The valley was caused by the WEEB® washer's conical penetrator.



**Figure 2.2-16 Photomicrograph of metal after removal of WEEB® washer**

The general rule on the use of WEEB® washers on solar panels is that each module should have at least two bonding points, and at least 4 WEEB® washer teeth forming the ground bond. Two points in contact creates redundancy and a safer installation.

Other Burndy products under the Wiley trademark are WEEB® Lugs, WEEB® Bonding Jumpers, Acme Cable Clips, Acme Conduit Entry boxes, and WILEY braids.

## 2.3 Application and Performance Testing

There are many standards organizations that provide both application recommendations and performance criteria to which electrical connections are tested. Most often the performance testing is directly associated with the environment and conditions to which a connector will be exposed over its lifetime. As such, the test programs are developed to simulate rapid acceleration of the conditions to which a connection will be exposed, and give reasonable assurance that the connection tested is suitable for the application.

Standards strive to strike a balance between ensuring suitability for an application while maintaining the capability to test in a reasonable time frame. Pressing connections to overachieve in non-realistic test conditions may force connections to be over-designed and possibly even limit the test facilities that can conduct the testing, both of which can lead to more costly products than an application requires. Also, test expenditures can change dramatically depending on the requirements set by a standard, and this will factor in to a connection's overall cost to the end user.

Standards organizations bring together knowledgeable individuals with expertise relating to connection design, testing and application. They often represent the user, installer and manufacturer. Together, these experts are able to review all concerns and generate a test program that sets minimum criteria which connections must meet to be considered appropriate for the application.

Table 2.3-1 and Table 2.3-2 summarize the most notable connector standards organizations, associated applications, and standards that relate to power connection technology. Connector performance standards that require testing and connector application standards that specify suitable connector types and/or usage are included.

Table 2.3-1  
Canadian/Mexican/National Electrical Codes Related Standards

Standards Organization ↓	Application								Associated Standard	Comments
	Generation	Transmission	Substation	Grounding	Underground Distribution	Overhead Distribution	Industry	Communications		
<b>ANCE</b> Asociación de Normalización y Certificación Mexico				p			p	p	NMX-J-543-ANCE <sup>T</sup>	<b>ANCE</b> is a private sector body authorized to grant NOM approval in electrical and gas products in Mexico.
				p			p	p	NMX-J-548-ANCE <sup>T</sup>	
					p		p	p	NMX-J-519-ANCE <sup>T</sup>	
				p					NMX-J-590-ANCE <sup>T</sup>	
<b>ATIS</b> Alliance for Telecommunications Industry Solutions U.S.A.				a	a	a	a	a	ATIS-0600029.2013	<b>ATIS</b> is a telecom standards organization; its standards are used in North America.
<b>CSA Group</b> Canadian Standards Association & CSA International Canada Operates globally				p					CSA C22.2 No. 41 <sup>T</sup>	<b>CSA Group</b> consists of: <b>CSA</b> is a not-for-profit standards development organization. <b>CSA International</b> tests, monitors, and certifies products for use in Canada and lists for use in the U.S.A.
				p			p	p	CSA C22.2 No. 65 <sup>T</sup>	
							p	p	CSA C22.2 No. 188 <sup>T</sup>	
					p		p	p	CSA C22.2 No. 198.2 <sup>T</sup>	
<b>International Electrotechnical Commission</b> Switzerland Operates globally		p					p		IEC 61238-1 connectors (to be divided into three parts, part 1 LV, part 2 LV IPC, part 3 MV w/short circuit)	<b>IEC</b> is a not-for-profit, non-governmental standards organization. Its members are National Committees.
<b>NEMA</b> National Electrical Manufacturers Association U.S.A. & Mexico			p				p		NEMA CC-1	<b>NEMA</b> membership is comprised of manufacturers. NEMA standards are user specified.
				p					NEMA GR-1	
<b>NFPA</b> National Fire Protection Association U.S.A. Operates in Americas				a			a	a	NFPA 70 (NEC) The National Electrical Code (and its counterparts in many other countries) is legally binding.	<b>NFPA</b> is a US trade association creates and maintains copyrighted fire & electrical standards & codes for usage & adoption by local governments.
				a					NFPA780	
<b>UL</b> Underwriters Laboratories, LLC U.S.A. Operates globally				ap					UL96A <sup>a</sup> , UL96 <sup>p</sup> , UL147 <sup>p</sup>	<b>UL</b> is a for-profit company that tests, monitors and lists products for use in the U.S.A. and certifies products for use in Canada. It maintains lists of tested products that are accepted by the AHJs.
				p			p	p	UL467 <sup>c</sup> , UL486A-486B <sup>T</sup> , UL486C <sup>T</sup> , UL 486D <sup>T</sup>	

<sup>a</sup> application based standard that guides connector selection and/or usage  
<sup>p</sup> performance based standard for connector qualification  
<sup>T</sup> tri-national (Canada, Mexico, U.S.A.) harmonized standard  
<sup>c</sup> bi-national (Canada & U.S.A.) harmonized standard

Table 2.3-2  
NESC (Utilities) Related Standards

Standards Organization ↓	Application								Associated Standard	Comments
	Generation	Transmission	Substation	Grounding	Underground Distribution	Overhead Distribution	Industry	Communications		
<b>ANSI</b> American National Standards Institute U.S.A.					p				ANSI-C119.1 <sup>M</sup>	<b>ANSI</b> membership is corporate, government, and individual. ANSI standards are user specified. NEMA is Secretariat for this standard.
		p				p			ANSI-C119.4 <sup>M</sup>	
						p			ANSI-C119.5 <sup>M</sup>	
			p		p				ANSI-C119.6	
<b>CIGRE</b> Council on Large Electric Systems France Operates globally										<b>CIGRE</b> is an international non-profit association promoting global collaboration to improve electric power systems.
<b>CSA Group</b> Canadian Standards Association & CSA International Canada Operates globally	p	p	p		p	p			C 57	<b>CSA Group</b> consists of: <b>CSA</b> is a not-for-profit standards development organization. <b>CSA International</b> tests, monitors, and certifies products for use in Canada and lists for use in the U.S.A.
<b>International Electrotechnical Commission</b> Switzerland Operates globally		p	p						IEC 61238-1	<b>IEC</b> is a not-for-profit, non-governmental standards organization. Its members are National Committees.
		p	p						IEC 61284	
<b>IEEE</b> Institute of Electrical Electronics Engineers U.S.A. Operates globally			a						IEEE C2 (NESC)	<b>IEEE</b> a professional association dedicated to advancing technological innovation and excellence for the benefit of humanity. IEEE standards are user specified.
			a	p					IEEE80 <sup>a</sup> , IEEE837 <sup>p</sup>	
							a		IEEE142	
								a	IEE1100	
<b>NEMA</b> National Electrical Manufacturers Association U.S.A. & Mexico			p						NEMA CC1 <sup>M</sup>	<b>NEMA</b> membership is comprised of manufacturers. NEMA standards are user specified.
				p					NEMA GR1	

<sup>a</sup> application based standard that guides connector selection and/or usage

<sup>p</sup> performance based standard for connector qualification

<sup>M</sup> bi-national (Mexico & U.S.A.) harmonized standard

## 2.3.1 General Test Parameters

Electrical connections used for power applications will tend to have some basic performance requirements recognized by all standards. For example, electrical connections must, obviously, provide a continuous path of continuity through the connection, and must be capable of maintaining that conductive path as installed. Thus, in addition to the electrical testing, mechanical testing is also required.

The application for which a connection is to be used further defines the testing requirements. If a connection is to be exposed to the environment, its ability to withstand corrosion will be considered. If a connection is to be subjected to extreme mechanical loading, then the testing will require high mechanical strength conditioning to ensure there is sufficient integrity for the application.

An important note on connection testing is that connectors subjected to an industry standard program are installed per the manufacturer's instructions unless stated otherwise in the test protocol. This important distinction provides baseline conditions (e.g. conductor cleanliness, oxide inhibitor use, tool type and condition) from which the manufacturer can establish a connector's performance. However, this also means that deviations from the installation instructions can yield significantly different results in the field. It has been found that technologies that reduce the dependency of the installer to create true electrical contact within the connection region, while also protecting and maintaining that contact over time, make for the highest quality and most reliable connectors. (Ref: Connector Application and Performance Survey)

## 3.0 PRACTICAL CONNECTOR CONCEPTS

In all electrical connector applications, there are issues other than theory to consider when making connection decisions. There may be several types of connection methodologies suitable for any given application.

In this section additional information is provided for making final connection selections. The information provided in this section covers three important aspects that relate to final selection; installation, infrastructure, and safety.

Means of installation, discussed in section 3.1, are very important for proper connector operation. Tooling, training, and proper application are just a few of the issues when considering installation. Without installation being performed correctly, the theoretical behavior of the connector is no longer valid.

A company's infrastructure (section 3.2) becomes very important when making connection selection decisions. The infrastructure referred to, here, includes the tooling already purchased and in place, training programs, and economic impact of final selections. Infrastructure parameters are essential in the connector decision process and will lead to superior results.

Finally, safety (section 3.3) must be considered throughout the entire connector selection program. Safety issues are involved from design through to installation and long-term performance.

### 3.1 Installation

Conductor joints and interconnections are part of every electrical circuit. It is of utmost importance that electrical connections be properly made. The fundamental requirements of any electrical connection are that it maintains both structural and electrical integrity throughout its expected life span. High quality materials and workmanship (in both the connector and during installation) are essential to ensure the basic connector requirements are achieved.



## 3.1.1 General Practice

Regardless of the connection methodology employed, there are many general practices that help ensure a good electrical connection. These practices result from many years of experience and testing, and must be considered for every connector installation.

### 3.1.1.1 Contact Surface Preparation

Surface preparation is essential to ensure proper contact between connector and conductor. Contaminants on the surface that get into the connection will greatly interfere with the establishment of a sound electrical connection. The following steps must be taken to prepare a contact surface for connection:

1. Removal of all corrosion and surface oxides along contact areas. Oxides naturally form on metallic surfaces with exposure to air, and in the case of some metals such as aluminum, the formation is relatively quick and transparent to the eye. Removal of oxides, on both the connector and conductor, is performed just prior to installation and can be adequately achieved by wire brushing. Plated surfaces should not be wire brushed.
2. If a connector or conductor surface is plated, removal of contaminants should be done with an appropriate cleaning solvent or similar compound that does not disturb the integrity of the plating.
3. A select few manufacturers will chemically etch and apply an anti-oxidant coating to all surfaces of the connector in its manufacturing process. The anti-oxidant coating, in addition to oxide inhibitor compounds, acts to retard the formation of aluminum oxide on un-plated aluminum. For connectors treated with an anti-oxidant coating during its manufacture, contact surfaces are assured of being oxide free and ready for connection. (To determine if an anti-oxidant coating has been applied to a connector, expose it to a black lighted (UV) lamp. Anti-oxidants will appear as a “whitish” coating when exposed to black light.) Connectors not treated with an anti-oxidant should be cleaned prior to installation.
4. Surface preparation also includes the removal of other contaminants from contact surfaces. Types of contaminants that may be present on a conductor surface are insulation particles, adhesives, tape, oil, dirt, and moisture. Regardless of the contaminants, removal is essential for proper electrical contact. Once again, contaminant removal should be performed without disturbing plated surfaces.

### 3.1.1.2 Insulation Removal

Conductor coverings and insulations protect the conductor from corrosion and mechanical damage, as well as provide electrical separation between conductive layers and/or from external contact. When installing a connector, the covering must be removed completely without damaging the underlying conductor. The exposed conductor region must be of sufficient length to accommodate the entire contact surface(s) of the connector.

Depending on the type of conductor, the removal of insulation (and re-insulation of the finished connection) can be quite complicated. Whether working with intricate conductors that have multiple layers of insulating and covering materials, or just simple jacketed cables, there exist some basic rules for insulation removal.

1. The insulation must be removed for a length just greater than the contact length of the connector to be installed. In the case of compression connections, the strip length must include additional length to compensate for the connector’s extrusion during crimping.
2. Regardless of the method used, the underlying conductor must not be damaged by cutting or nicking during the insulation removal process. Cut or nicked strands reduce the cross sectional area of the conductor, introduces stress concentrations, and may result in eventual failure.

3. After the conductor is stripped and all insulation is removed, follow the guidelines for contact surface preparation and, when necessary, apply oxide inhibitor.

### 3.1.1.3 Oxide Inhibitors

Mechanical and compression connections generally require coating contact surfaces with an oxide inhibiting compound. These compounds have many attributes that ensure good contact and enhance the longevity of the connection. Although discussed in numerous sections within this paper, a compiled list of benefits of using oxide inhibitors is presented below.

- Penetration of oxide layers helps produce low initial contact resistance, resulting in improved connection conductivity.
- Prevention of oxidation and other corrosion by sealing the joint from air and contaminants.
- Assistance in increasing pullout strength of the connection, when needed.
- Continuance of properties to maintain connection integrity over wide temperature ranges.
- Compatibility with cable insulation.

In many cases, the connector manufacturer will determine the appropriate oxide inhibitor and supply the connector factory filled with that compound. Where the connector is not pre-filled, two general types of compounds are available depending on whether copper or aluminum is to be joined. Both types are suitable for pad-to-pad and contact groove-to-conductor connections.

It should be noted that oxide inhibitors are not to be used with other connection technologies, including any fusion type connection and implosive fittings.

### 3.1.1.4 Hardware

All clamp type connections, including the pad-to-pad applications, depend on the force developed by fastening hardware to provide stable electrical joints. For hardware to adequately perform this task, it must (a) be strong enough to withstand the torque requirements recommended by the connector manufacturer, (b) develop the correct force and resultant pressure for the recommended installation torque, and (c) must remain reliable for the entire expected service life of the connection. To achieve optimum efficiency, the bolt/nut/washer combination must be appropriately selected for the conductors being joined. There are two distinct groupings of hardware for making electrical connections:

1. Hardware supplied with the connector assembly. Most mechanical connectors are supplied with appropriate hardware to complete an electrical connection. The hardware supplied is best suited for both the intended application and the connector material. Copper alloy connectors will normally be supplied with silicon bronze, or DURUM™ hardware. Aluminum connectors are generally assembled with aluminum alloy hardware. Aluminum alloy hardware components are lubricated to prevent galling and to provide consistent clamping force.
2. Hardware obtained separately. Supplementary hardware is often required to complete an electrical connection. Selecting the proper hardware helps to ensure that connection integrity will last. Figure 3.1-1 and Table 3.1-1 provide hardware assembly and selection criteria for connecting various conductor materials. Termination hardware kits are available to ensure proper field installation. (See section 3.1.1.4.1 for further details on terminal hardware considerations.)

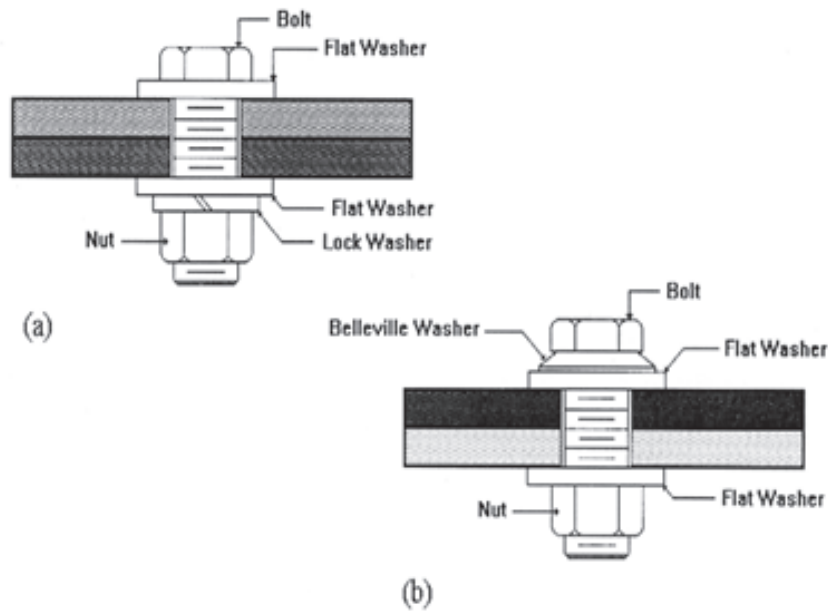


Figure 3.1-1 Bolted Joints

Bolted Joints						
Table 3.1-1						
Recommended Hardware Materials (Quantity per Bolt)						
Materials Being Joined	Bolt (1 each)	Nut (1 each)	Flat Washer (2 each)	Lock Washer (1 each)	Belleville Washer (1 each)	Reference Figure 2.1-1
Copper to Copper	SB	SB	SB	SB	NR	(a)
	SS	SS	SS	SS	NR	
Copper to Aluminum	SB*	SB*	SB*	NR	SS	(b)
	SS	SS	SS	NR	SS	
Aluminum to Aluminum	AL	AL	AL	AL	NR	(a)
	SS	SS	SS	NR	SS**	(b)
Copper to Steel	SB	SB	SB	SB	SS**	(a) or (b)
	SS	SS	SS	SS	NR	(a)
	GS	GS	GS	GS	NR	
Aluminum to Steel	SB*	SB*	SB*	NR	SS	(b)
	SS	SS	SS	NR	SS	
	GS	GS	GS	NR	SS	
<b>Key:</b>	NR Not Required		GS Galvanized Steel			
	SB Silicon Bronze		* Tin Plated			
	AL Aluminum		** Alternate recommendation in place of lock washer			
	SS Stainless Steel					

A critical aspect when installing hardware is the torque used to tighten the components. Every field termination, from a low voltage screw terminal to the largest lug, has an optimum value of torque that produces the most reliable, low resistance joint.

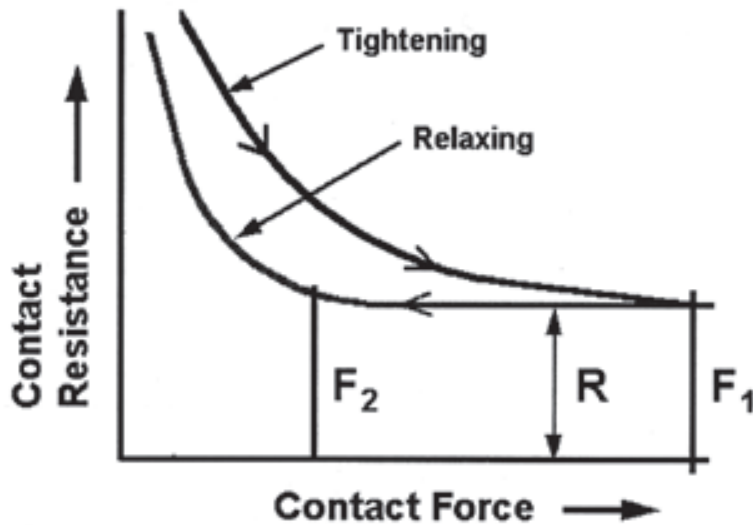
Torque is the result of a force applied to a lever arm multiplied by the distance measured from the pivot point to the point along the arm where the force is applied ( $d \times F$ ). In the U.S. (formerly English) system of units, where force is in pounds and distance is in inches, torque has the units of pound-inches, or lb-in. In the International System of Units (SI), force is in newtons (N) and distance in meters (m) with torque in newton-meters, or N·m.

Some years ago the electrical industry established optimum torque values for the most common materials and sizes of hardware used for electrical connections. Table 3.1-2 lists the results of this work.

It is often asked whether bolted connections require periodic retightening. The simple answer is NO. Once the connector is installed with the proper torque, repeated tightening could actually damage the connector and/or the conductor and eventually lead to a failure.

Figure 3.1-2 illustrates how tightening of a bolt affects contact resistance. When the bolt is tightened to produce a contact force of  $F_1$ , the contact resistance is brought down to  $R$ . Through creep and temperature cycling, the connection materials may undergo relaxation resulting in a contact force of  $F_2$ . As seen in Figure 3.1-2, however, the relaxation curve differs from the tightening curve. Although the materials relax to a contact force of  $F_2$ , the contact resistance remains relatively constant, indicating a stable connection throughout the contact force range from  $F_1$  to  $F_2$ .

<b>Recommended Tightening Torque</b>		
Table 3.1-2		
<b>Bolt Size*</b>	<b>DURIUM™ (silicon bronze) Stainless Steel Galvanized Steel (lb-in)</b>	<b>Aluminum (lb-in)</b>
1/4 - 20	80	—
5/16 - 18	180	—
3/8 - 16	240	168
1/2 - 13	480	300
5/8 - 11	660	480
3/4 - 10	960	650
* Thread classes are UNC-2A (external) and UNC-2B (internal)		



**Figure 3.1-2 Bolt Force Relaxation Curve**

Tightening the bolt beyond producing a contact force of  $F_1$  does not result in a better connection. The only effect of increasing torque is possible damage. Therefore, better practice is to initially install hardware with the recommended torque values, and then periodically check for signs of loosening or overheating before making any adjustments.

Finally, the method of installing Belleville spring washers is often misunderstood. In fact, there are varying opinions as to what is the “correct” method. Among these differing views, the following is a successful time-tested procedure. (Refer to Figure 3.1-1 b for assembly details.)

1. A flat washer is placed between the concave side of the Belleville washer and the surface of the member being joined. The Belleville is thus captured between the head of the bolt and the large flat washer. The flat washer should have an outside diameter greater than the flattened Belleville’s such that no overhang results. Select a flat washer that is twice as thick as the Belleville for strength. (If not available, stack two or three thinner washers to achieve the same effect.)
2. With the Belleville washer captured between the flat washer and the bolt head, fit the assembly into its hole. When the washers are fitted in position, there should be no interference with washers of adjacent bolts and no overhang over surface edges.
3. Tighten the nut on to the bolt (with a washer of its own) until a sudden, noticeable increase in torque is required to continue. The Belleville washer is now flat. It is not necessary to “back off” the nut after tightening to this point.

#### **3.1.1.4.1 Terminal Hardware Considerations**

Within limits, the resistance of a bolted joint will decrease and its mechanical strength will increase with an increase in the size and number of bolts employed. Utilizing this fact, bolted terminal connectors are commonly available in one-hole, two-hole, and four-hole configurations. A further increase in the number of bolts beyond four produces little appreciable increase in joint efficiency, except for very wide conductors. By combining existing performance data and the mechanics of bolted joints presented in earlier sections, it is possible to generate guidelines for selecting one-, two-, and four-hole bolted terminations.



In the case of one-hole terminals, a single bolt is used to make the connection. While offering the simplicity of installation, the single bolt produces an electrically sound, compact connection. In static applications, the one-hole terminal will perform very well. However, unless the connector pad is adequately constrained to prevent rotation, torsional movement may overcome the hardware installation torque and loosen the connection.

Two-hole terminals have longer pads and require two bolts for installation. The longer pad offers increased electrical performance due to a larger contact surface area. Also, employing two bolts in the connection eliminates the problem of rotational forces loosening the connection.

Four-hole terminals will further increase both mechanical and electrical performance. More contact surface area is available with the larger pad, and the even pressure applied by using four bolts takes advantage of the increased surface area for electrical conductivity.

When selecting between terminal types for connection installation, consider the following list of criteria:

1. Preparation of interface surfaces. (See 3.1.1.1)
2. Provisions for the effects of thermal expansion of the bus and terminal. (See 1.4.1 and 3.1.1.4)
3. Proper bolt-tightening torque. (See Table 3.1-2)
4. Current per unit of contact area for normal and short circuit conditions.
5. Bolt spacing and current per bolt.

Use the information provided in sections (a) and (b) below to determine items (4) and (5) above, and finalize selection between one-, two-, and four-hole terminals.

a) Determination of Pad Thickness

Example 1: What size pad is required to safely conduct 1000 amps?

Assume a copper pad thickness of manageable size; 1/4 in. thick. To conduct 1000 amps, using the value for copper in Table 3.1-3, we have

$$1000A = \left(1000 \frac{A}{in^2}\right) \times \left(\frac{1}{4}\right) \times w$$
$$w = \frac{4}{1in} \times (1000A) \times \left(\frac{1in^2}{1000A}\right)$$
$$w = 4in$$

When considering an aluminum pad, substituting 700 A/in<sup>2</sup> for 1000 A/in<sup>2</sup> results in a pad (5.714 in.) almost 6 in. wide.

Thus, a pad of copper 1/4 in. thick 4 in. wide or one of aluminum 1/2 in. thick by 3 in. wide will safely conduct 1000 amps.

Table 3.1-3 Cross-Sectional Ampacity	
Material	Current Capacity (A/in <sup>2</sup> )
Aluminum	700
Copper	1000

b) Determination of number of bolts

Example 2: How many bolts are required to secure the pad from Example 1?

Assuming the use of 1/2 in. bolts, from Table 3.1-4, below, each provides sufficient clamping force to carry 300 amps. The number of bolts to conduct 1000 amps is,

$$\left( \frac{1000 \text{ Amps}}{300 \frac{\text{Amps}}{\text{bolt}}} \right) = 3.3 \text{ bolts}$$

Thus to secure the ¼ in. x 4 in. copper pad carrying 1000 amps, four ½ in. bolts are required.

If 5/8 in. bolts are used, three bolts will be required but it may be difficult to find such a terminal lug. Note: If a calculation results in a recommended quantity of bolts greater than four, an adjustment in bolt size and/or pad size is possible and desirable in order to yield a better connector design or selection.

Table 3.1-4 Amperes per Bolt Influence Area	
Bolt Diameter (inch)	Current Capacity (A/bolt)
<1/2	225
1/2	300
5/8	375
3/4	450

\* NOTE: These current values represent the current flow enabled by the bolt due to its applied contact pressure, and NOT the current capacity of the bolt itself.

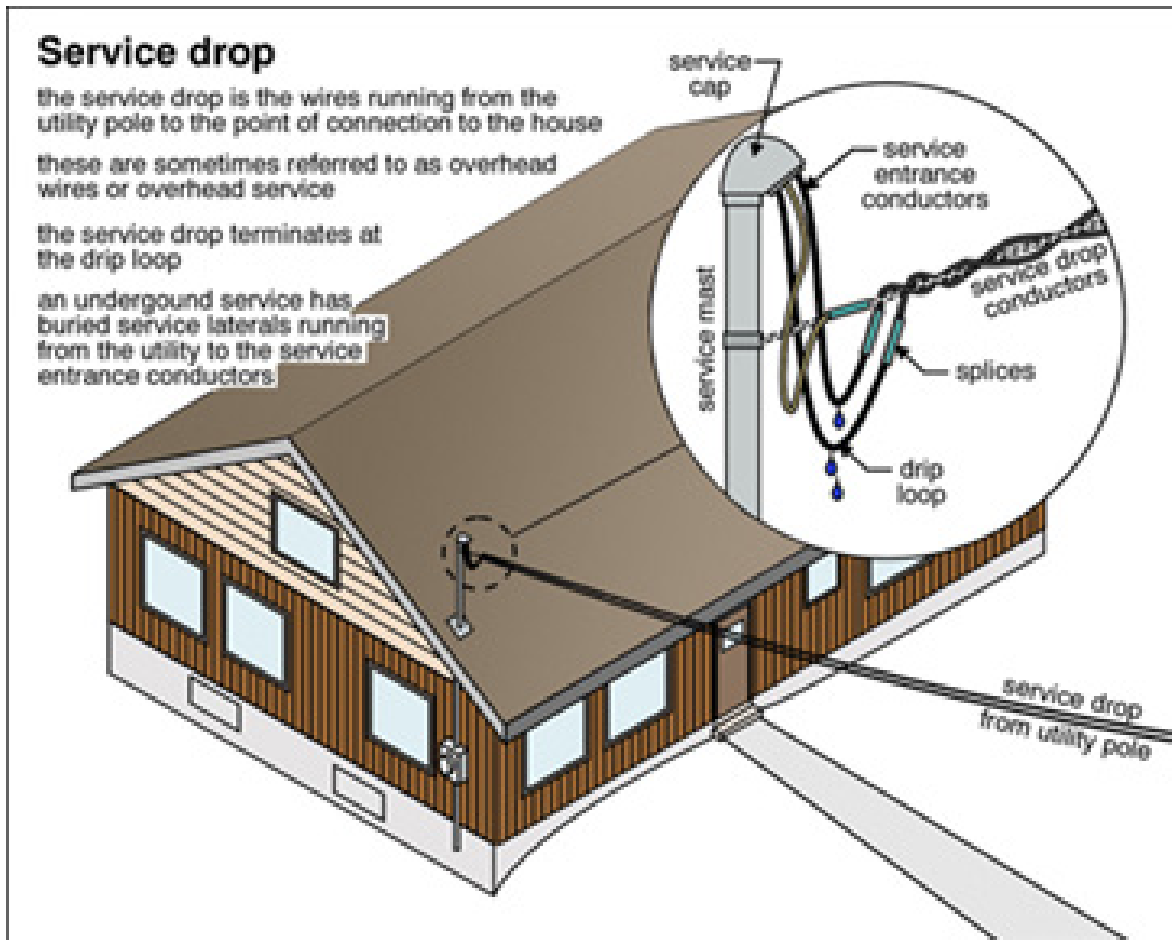
### 3.1.1.5 Aluminum Above Copper

As briefly mentioned, in section 1.4 Overhead, outdoor installations where mixed metals are used, aluminum conductors must be installed above copper conductors whenever possible (Fig. 3.1-3). Moisture on copper conductor surfaces will accumulate copper ions. If positioned above aluminum, these copper salts will wash onto the aluminum and cause galvanic corrosion.

In the event the aluminum conductor is located below the copper, a “drip loop” should be provided on the copper conductor. The drip loop redirects the copper conductor around and below the aluminum conductor for attachment. The loop formed allows corrosive moisture to drip from the copper conductor safely below the aluminum.



**Figure 3.1-3 Al above Cu when installed outdoors**



**Figure 3.1-4 Service Drop Drip Loop**  
(Illustration courtesy of Carson, Dunlop & Associates Ltd.)

### 3.1.1.6 Plating

Various plating materials and processes are used on electrical connection products. Table 3.1-5 contains a short list of possible reasons for plating and the corresponding types of plated connectors suitable for meeting that objective.

Table 3.1-5 Plating Applications				
Objective	Electro-tin	Hot Tin Dipped	Nickel	Silver*
Reduce galvanic corrosion (bimetallic)	X	X	—	—
Resist corrosive elements	X	X	—	—
Increase conductivity/lower contact resistance	—	—		X
Provide high, continuous service temperatures (maximum)	—	—	X (650°F / 343°C)	X (500°F / 260°C)
* Joining aluminum to a silver plated surface will result in a highly corrosive high resistance connection.				

### 3.1.1.7 Sealed Tongue Terminals

Many compression terminals are manufactured via a tube flattening process to form the pad area. As a result, a thin seam may exist down the center of the pad through which moisture or oil may seep into or from the compression barrel. The sealed tongue terminal is brazed internally and then electro-tin plated to prevent moisture and oil from migrating through the seam. After plating, to ensure an effective seal the compression barrel is pressure tested to 5 lb/in<sup>2</sup> (psi).

The value of a sealed tongue terminal is usually not required for use in “normal” service applications with low moisture environments and non-oil-filled cables. When using oil-filled cable, or when high moisture levels are expected, the use of sealed tongue terminals or other means of sealing is warranted.

### 3.1.1.8 Standard Wall and Heavy Wall Compression Connectors

“Standard wall” and “heavy wall” are terms referring to the thickness of the material of a compression connector barrel.

Standard wall products are used to connect all covered and bare ASTM classes and stranding types of copper and aluminum wire conductors (including flexible and extra-flexible). They are usually used in minimum tension, are UL listed (or recognized) for NEC applications and conform to UL486A-486B requirements. Standard wall connectors are typically tin-plated and not exposed to either wet, damp or corrosive environments (either indoors, in panel boxes, or cabinets).

Heavy wall products are suited for all covered and bare ASTM classes and stranding types of copper and aluminum cable as well as bi-metallic type conductors (e.g. ACSR, Alumoweld, and Copperweld) in applications conforming to ANSI C119.4 requirements. Table 3.1-6 and Table 3.1-7 provides summaries of the two types of compression barrels.

**Table 3.1-6  
Summary of Standard and Heavy Wall Tension Tests**

Standard	Requirement	Standard Wall	Heavy Wall
<b>ANCE NMX-J- CSA C22.2 No. 65 UL 486A-486B</b>	Pullout: Al-Al Al-Cu Cu-Cu	X	—
<b>ANSI C119.94</b>	Class 1, Full tension 95% RBS	—	X
	Class 1A, Normal tension 60% RBS	—	X
	Class 2, Partial tension 40% RBS	—	X
	Class 3, Minimum tension 5% RBS	X	X

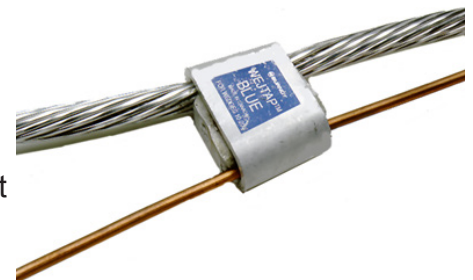
**Table 3.1-7  
Summary of Standard and Heavy Wall Current Cycle Tests\***

Standard	Requirement	Standard Wall	Heavy Wall
<b>ANCE NMX-J- CSA C22.2 No. 65 UL486A-486B</b>	500 cycles Al-Al Al-Cu Cu-Cu	X	—
<b>ANSI C119.4</b>	Class AA, Extra Heavy Duty, 500 cycles Control at 175°C to 180°C	—	X
	Class A, Heavy Duty, 500 cycles Control at 100°C to 105°C	—	X
	Class B, Medium Duty, 250 cycles Control at 100°C to 105°C	—	X
	Class C, Light Duty, 125 cycles Control at 100°C to 105°C	—	X

\* Current Cycle Submersion Test not included

### 3.1.2 Wedge Installation

Wedge connectors are distinct connections which, depending on the type, may be installed with standard lineman's hand tools or a powder actuated tool system (see Figure 3.1-5 for connection). Similar to mechanical connector installations, wedge connectors installed with lineman's tools should be done according to the manufacturer's instructions. The powder actuated, or fired-on, wedge requires somewhat different installation methods. The steps below outline a general process for installing a fired-on wedge connector. Read and follow the specific manufacturer's instructions included with the tool and connectors for all appropriate safety and installation practices.



**Figure 3.1-5 A completed wedge connection**



1. Carefully select the proper connector according to the conductor sizes being joined. Proper selection may involve either checking the catalog, the packaging, or the connector itself to see if the conductor sizes are accommodated. Computer programs can be used to obtain exact cable diameter accommodations.
2. Match the color code on the wedge connector (red, blue, yellow) to the color of the power booster. The color marking dictates the proper power booster to choose for the wedge to be correctly installed. [Note: As an option, the correct installation power booster can be packaged with the connector for convenience.]
3. Choose the matching installation tool frame based on the color code of the wedge connector to be installed - the smaller tool frame is for red and blue connectors, and the larger tool frame is for yellow coded connectors (Fig. 3.1-6).



**Figure 3.1-6 Wedge Connection Installation Tool**

4. Follow all applicable general installation practices for connector and conductor preparation described earlier.
5. Position the connector on the conductor. Correct positioning of the connector involves placing the conductors between the wedge and against the C-body. The tap can be above or below the run. The wedge should be positioned so that the large groove is placed against the larger conductor. This side is identified by a chamfer on the wedge.
6. Load the tool according to the manufacturer's instructions. Follow the instructions closely to complete the installation. After the connection is made (Figure 3.1-5), look for the manufacturer's embossment on the wedge, that the locking skive is visible (Figure 3.1-7), and general soundness of the connection.

The fired-on wedge connection is an intricate system and care must be taken to carefully and accurately follow the published installation instructions to ensure both a sound electrical connection and personal safety.



**Figure 3.1-7 Manufacturer's mark embossed on end of wedge by installation tool**

### **3.1.3 Compression Installation**

Compression connections will often require a few special considerations in addition to the general installation practices. These topics are discussed in this section and should be utilized in conjunction with the general guidelines (see 3.1.1).

#### **3.1.3.1 Cable Insertion**

In order to install a compression connector such that its performance is to specification, the conductor must be inserted for the entire length of the crimp barrel. Full insertion will result in maximum surface contact

area between the connector and conductor, helping to ensure a sound electrical connection. The following installation steps will assist in meeting the full insertion requirement.

1. Pre-mark the cable: Lay the connector's compression barrel along the end of the conductor until the inner-most crimp line is even with the conductor's edge. Mark the conductor with a pen or tape even with the open end of the barrel. This mark will provide the installer with a visual identifier of full insertion.
2. Insertion: As the cable is inserted into the barrel, a twisting action of the connector/conductor may be necessary along with the insertion force. Twisting especially helps when the barrel is lined with an oxide inhibitor. Wipe away excess inhibitor compound as it extrudes out of barrel openings.
3. Completion: When the conductor mark (or tape) is flush with the end of the connector's barrel, the cable is fully inserted.
4. Sector cable: Sector cable presents an additional problem when using compression connectors. Due to its triangular shape, sector cable does not insert into a round compression barrel. As a result, rounding dies were developed to shape the conductor to match the round barrel. Therefore, prior to inserting sector cable into a compression barrel, pre-round the entire insertion length using the applicable rounding dies. Follow steps 1 through 3 above for completing the insertion process.

There is an unsanctioned field practice of adding or, even worse, removing conductor strands during the insertion process to facilitate installation. This practice is NOT recommended and could result in a dangerous situation. Changing the original conductor stranding by adding or removing strands can lead to improper compression which may adversely affect the integrity of the connection and, if applicable, void its listing.

### 3.1.3.2 Bias Cuts

When using a connector that requires conductor insertion, the squareness of the cut end is important. Cables that are not cut squarely may result in the following undesirable conditions:

- Incomplete cable insertion and partial compression of the conductor at the first crimp.
- Insufficient distribution of the oxide inhibiting compound on the connector's inner wall and around the conductor.
- Errors in determining the proper conductor strip length.

### 3.1.3.3 Compression Installation Tooling

Compression connectors are installed with engineered tooling. In some cases there may be several tools and corresponding dies allowed for installing a particular connector. The use of matched tool, die and connector combinations is important when installing the compression connector.

A compression tool, whether mechanical, hydraulic, or battery powered (an example is shown in Figure 3.1-8), can accommodate a finite range of connectors. The connector specification sheet, catalog page, and/or packaging will list the recommended installation tools. Selecting the proper tool for your application is the first step to making a sound electrical connection.

Crimp dies are designed with a particular tool/connector/conductor application in mind. Once again, the die selection is an important component in the compression installation process. The connector will



**Figure 3.1-8 Battery Powered Hydraulic Crimp Tool**

normally be stamped with the die index codes to indicate suitable crimp dies. Final die selection will need to also match the installation tool chosen.

Installing the compression connector requires the correct number of crimps to be applied with the tool and die. Making too few crimps can seriously impair the long-term performance of a connection. Crimp information is in the catalog, on the specification sheet, and directly on the connector itself. Clearly marked knurls or color bands indicate both the position and the number of crimps to be applied.



**Figure 3.1-9  
Compression Splice**

Each compression connector function has general guidelines for making crimps.

Splices: Normal practice is to start the crimping from the middle, or innermost, crimp spaces. An example of a splice is shown in Figure 3.1-9. Crimping is performed on alternating sides (right and left), moving out towards the ends of the connector. This process allows the material to extrude outwards, thereby reducing electrical and mechanical stress points. (See section 3.1.3.5 Bird-caging for potential problems with

this method.)



**Figure 3.1-10 Compression Terminal**

Terminals (Fig. 3.1-10): Similar to splice connectors, crimping of terminal connectors should start from the point closest to the tongue (pad). Successive crimps are made moving towards the end (mouth) of the barrel. Again, this reduces high stress points in the completed connection.



**Figure 3.1-11 Compression Tap**

Tap (or tap splice, not a t-tap)(Fig. 3.1-11): Depending on the size of the compression tap connector, beginning the crimp in the middle of the connector is usually good practice. However, because a tap connector does not constrain material flow in either direction, crimping may begin from the most convenient location and proceed

continuously along the connector.

### 3.1.3.4 Bowing (“bananaing”)

Bowing refers to the curvature that can occur on a completed compression connection. The bowing is sometimes caused by the curvature of the cable that comes from being wound onto and being stored on a reel or from just being coiled or misalignment of the tool during crimping. During the compression (crimping) process, the sleeve material enters a “plastic” state, and can be easily influenced to bend with little force. Therefore, if unopposed, the wire conductor’s tendency to curl will cause the final connection to be bowed.

There are two ways to reduce or eliminate bowing. First, when feasible, the cable conductor should be straightened as much as possible before being inserted into the connector sleeve. Straightening the cable eliminates the primary force that causes bowing. Second, the operator can carefully apply force, by hand, opposite to the bow direction to straighten the sleeve. It takes surprisingly little effort, while the materials are being compressed, to counter the tendency of the connector to bow.

### 3.1.3.5 Bird-caging

Bird-caging refers to the separation of cable conductor strands near the entrance or mouth of a compression barrel. This phenomenon occurs when two (or more) metals with different physical properties are extruded

together, as in the compression connector installation process where the connector sleeve and wire conductor are not the same alloy material and geometry. Unequal plastic deformation results from the different extrusion rates, and when one material is stranded wire, the individual strands may separate.

As an example of how bird-caging can occur, take the compression butt splice connector. The normal installation process, as described earlier, would be to apply the first crimps at the center location, locking the conductor strands at that end. Successive crimps are made moving out to the connector ends. When the materials differ (conductor and compression sleeve), different extrusion rates are involved. Since the cable strands were locked on the first crimp, extrusion of conductor material can only occur towards the sleeve end (mouth) as the strands under the outer ply also constrain movement. By the final crimp, the faster extruding conductor strands are constrained on the connector side by the crimps and along the conductor by either the wire insulation or simply the twist of the strands. With both sides thus constrained, extruded conductor material bunches in the middle (separation of plies) the outer plies being longer than the inner resulting in loosening of the outer strands or the bird-cage effect.

Bird-caging does not have a detrimental effect on the overall connection. However, it is desirable to minimize or eliminate this condition to avoid areas that could produce corona or cause uneven current distribution outside of the connection. One method used to eliminate bird-caging is to use a compression sleeve designed to be crimped from the outer position (mouth of the connector) first. This type of compression connector must have pressure relief holes located at the center of the sleeve to allow the oxide inhibitor to bleed out as crimping takes place. With this connector type, the first crimp locks the cable strands at the end or mouth of the connector and the subsequent compression causes the extrusion to take place within the connector sleeve.

### **3.1.3.6 Spaced and Overlapped Crimps**

Spaced crimps refer to individual crimps made in separate, distinguishable locations along the compression sleeve. Overlapped crimps are made such that one crimp is made partially (about 1/4 of a crimp width) on top of a preceding crimp.

Both methods produce functionally acceptable connections. However, overlapping crimps offer the advantage of facilitating preparation of the finished connection, especially in high voltage applications, where a relatively smooth crimp profile is desired. Some flash may remain after overlapping crimping that can be easily removed if required.

Spaced crimps result in individual indentations in the connector sleeve between the knurls or ink marks. In most cases, especially lower voltage applications, the connection does not require post finishing procedures to remove flash.

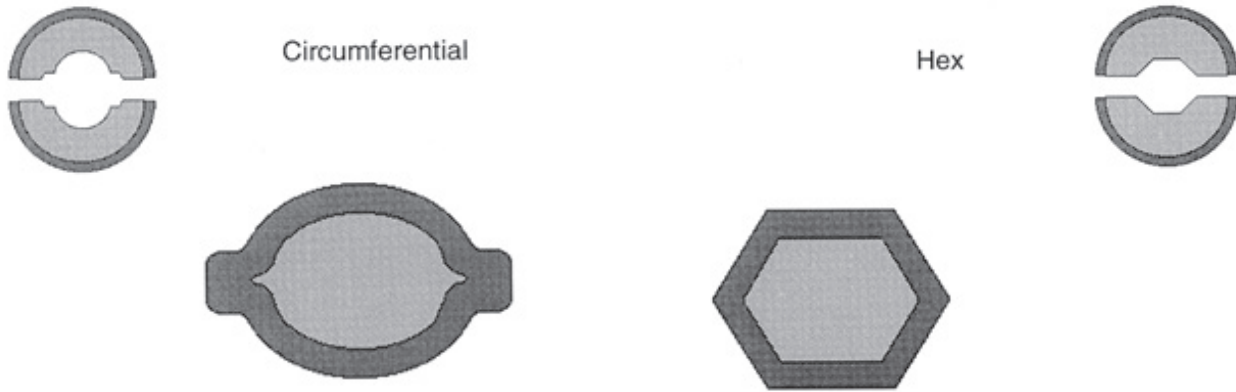
[Note: Regardless of the method used, no crimps should be made on the tapered ends or beyond the crimp lines of compression connectors and the specified number of crimps must be completed.]

### **3.1.3.7 Crimp Configurations**

There are several crimp configurations available for crimping compression connectors; the most popular in North America being circumferential and hexagonal (hex). Figure 3.1-12 depicts the die configurations that produce circumferential and hex crimps.

Circumferential dies produce circular indents on opposite sides of the compression barrel. There will normally be a thick region of flash extruded between the indents. This flash material is simply a redistribution of the connector material and must not be removed. When a circumferential crimp is to be insulated for use at higher voltage applications (above 5 kV), the gaps around the flash areas must be filled with a suitable inert material to remove air pockets and ensure dielectric integrity.

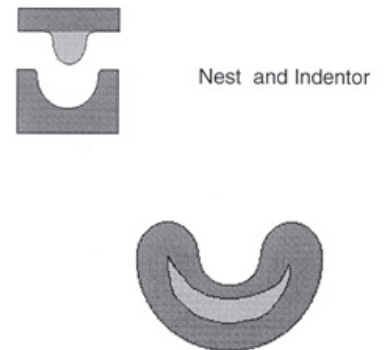




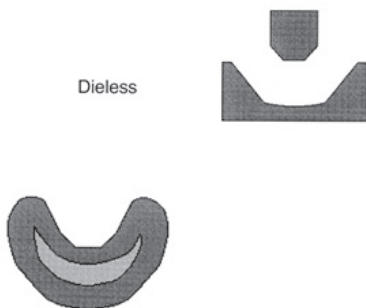
**Figure 3.1-12 Crimp Configurations**

Hexagonal (Hex) dies, like circumferential dies, produce a uniform compression crimp. In the process of crimping, a thin, sharp flash may result on the completed crimp. The flash must be removed to prepare the connector for use at higher voltages due to the need for a smooth finish. Also, care must be taken to remove flash to prevent damage to applied insulation and reduce the safety risks of cut gloves or skin of personnel. Note that removing flash from the connector will result in plating removal as well, possibly requiring the application of a secondary means of corrosion protection.

Other crimp configurations available include nest and indenter (longitudinal) and dieless (Figure 3.1-13). Nest and indenter crimps are made with a die set consisting of the “nest” die, which cradles the tubular barrel being crimped, and the “indenter” die, which compresses and cold-works the conductor and connector into a sound crimp. Nest and indenter crimps are uniform and easily inspected, resist pullout, and provide secure connections to flexible and extra-flexible stranded conductors. However, nest and indenter crimps require the finished crimp indentation to be filled for high-voltage installations, are not suitable for tension applications, and are not recommended for solid conductor.



**Figure 3.1-13 Nest and Indenter Configuration**



**Figure 3.1-14 Dieless Configurations**

Dieless installation tools (Fig. 3.1-14) are essentially self-contained crimp devices that eliminate the need for separate dies. The crimp geometry is very similar to the nest indenter configuration, where the head of the tool acts as the nest and the tool ram acts as the indenter. Dieless tools accept a wide range of conductor sizes (e.g. #6 AWG to 1000 kcmil), accommodating both aluminum and copper conductor, and provides for inspectability by embossing a mark in the crimp area. Crimps made with dieless tools have the same disadvantages as nest indenter crimps. An extensive list of die and dieless compression crimp configurations are available other than those described above (e.g. symmetrical, “B,” “D,” two-indent, and quad or four-indent). Although very specific connections may utilize one of these configurations, their overall use and general application is limited due in large part to the performance and

universality of the more popular crimp styles.



### 3.1.3.8 Conductor Stranding and Materials

#### 3.1.3.8.1 Concentric, Compressed & Compact Conductor

When making compression connections, it is also important to consider the conductor itself, both its material and stranding, for any given size. Stranded conductors are available in many forms, such as concentric round (full diameter), compressed (3% diameter reduction), and compact (10% diameter reduction). When working with stranded conductors in these various forms, it is often asked what compression connector is appropriate.

A compression connector that is specified for use with aluminum conductor only will functionally accept concentric, compressed, and compact aluminum of the same AWG/kcmil wire size. Similarly, a compression connector that is specified for copper conductor only will accept concentric, compressed, and compact copper of the same AWG/kcmil wire size.

When fitted into the compression sleeve, the smaller diameter cables (compressed/compact) may appear “loose” prior to compression. This is simply due to the fact that the cable is, in effect, compressed by the wire manufacturer. When the crimps are made, the same compression connection integrity will result as with larger diameter cables (of equal cross-sectional area). Connections to compressed and compact conductors have been thoroughly tested in the laboratory and in the field with successful results.

Any compression connector that accepts ACSR will not accommodate compact copper or aluminum conductor of the same nominal size. These connectors have larger barrel sizes in order to accommodate the larger ACSR and do not work with the much smaller compact copper and aluminum conductors. However, ACSR compression connectors will accommodate compressed and compact ACSR conductor of the same cable size.

#### 3.1.3.8.2 High Temperature Conductors (ACSS, ACCC, ACCR)

High-temperature conductors have become very popular alternatives to the more common ACSR (Aluminum Conductor Steel Reinforced) conductors, especially in transmission. The idea of these new conductors is to have the core support the weight and the line tension with little mechanical load on the aluminum strands, which are annealed in the manufacture of the conductor. This allows the aluminum strands to carry most or all of the electrical current. These stronger cores can be strung at higher tension than conventional cable, and have little sag during operation, even at elevated operating temperatures. Thus, although higher in cost than traditional ACSR, these new conductors promise increased electrical loading (with higher revenue potential) along the same right-of-way, without increased cost in adding tower supports. New projects constructed with a high-temperature conductor (lightly loaded initially) will have built-in capacity for future electrical load growth without re-conductoring (replacing the conductor).

Although these new conductors are increasing in use, options for connections are not as widespread. When selecting a specialized conductor, it often requires a specialized connector to be able to take full advantage of higher temperature operation.

ACCC (Aluminum Conductor Composite Core) and ACCR (Aluminum Conductor Composite Reinforced) conductors currently require the use of very specific compression connections. The connectors were developed to grip the cores without damaging the inherently brittle materials. These conductors also come with trapezoidal shaped strands that were taken into account in the development of the connectors.

ACSS (Aluminum Conductor Steel Supported) conductor has been in the industry for decades, originally being designated SSAC. This conductor consists of a high strength steel stranded core surrounded with

aluminum wires. ACSS is provided with either round or trapezoidal aluminum strands (the latter designated ACSS/TW). As with ACCC and ACCR, the aluminum strands are annealed in manufacturing. Recent improvements to this conductor have been made to the core material, increasing its tensile capacity while reducing elongation (and sag) at higher temperatures. In addition to the compression sleeves that have been developed for ACSS, implosive connectors are also suitable and even preferred (see implosive advantages).

## **3.2 Infrastructure**

An organization's established infrastructure is a major consideration in the overall scheme of electrical connector and electrical connection system selection. Infrastructure is defined here as the underlying policies, procedures, culture, and equipment already in place within an organization. Information regarding the organization's infrastructure is an important component of the decision making process in implementing a connection system. Understanding infrastructure ultimately relates to the safest, most economical and reliable connector solution that is presently most suited to an organization, and can lead to an effective means of implementing new technologies as they become available.

### **3.2.1 Total Cost of Ownership**

Total cost of ownership of an electrical connection system involves several components; up-front costs, installation costs, maintenance costs, and the cost of failure.

#### **3.2.1.1 Up-front Costs**

Up-front cost, or initial cost of acquisition, will include many or all of the following items:

- Purchasing the specific connector.
- Adapting or modifying a connector to be compatible with an existing system.
- Acquiring a connector/tool system.
- Appropriating new tool technology for existing connector selections.
- Adding relevant training for new installation and maintenance procedures.

Evaluation of a connector cannot be based solely on the connector's acquisition cost. The specific application may dictate the choices available, regardless of cost issues.

Many connection systems require the use of specialized tooling and training for successful installation. Compression connectors require a full complement of specialized tooling to install. Similarly, wedge connectors require a different set of special tools for assembly. For a company trained and equipped to install one system, the costs associated with switching to an alternative may initially seem cost prohibitive. However, an in depth cost analysis could justify a switch, or lend further support to keep the presently used system. In any case, the costs of in-house tooling must be included in the acquisition cost of each connector on a depreciated type basis. This process ties in directly to the next topic of installation cost.

#### **3.2.1.2 Installation Costs**

Installation costs are directly related to the cost of installing the connector (tooling and equipment) as well as the time to complete the installation process.

The cost of the tooling may be depreciated over the number of installations made. This consideration is often included in the original tool purchase justification. However, the tool's cost may be factored directly into the cost per connection to accurately capture all of the costs associated with a connector installation.

The time required to complete an installation directly affects labor costs, and may indirectly affect the company's profitability, especially when considering the costs of lost opportunity. Installation time is

dependent on the connection type itself, the type of tooling (if required), the proficiency of the installer, and the environment in which the installation is being made.

Regardless of the accounting methodology used, it is important to understand how the connector selection process relates to the total installed cost. Capturing this information can affect future decisions regarding connector systems within the organization's infrastructure. Making sound estimates of these costs and documenting the decision process helps to avoid revisiting previously made decisions.

### **3.2.1.3 Maintenance Costs**

Specialized installation tooling requires maintenance. Calibrated tooling and equipment must be maintained to ensure proper connector installation. Generally, the company will institute a tool repair and maintenance program to maintain the satisfactory condition of installation tools. Part, or all of this program may entail utilization of the original tool manufacturer's warranty and expertise in servicing tools. Either way, there is cost involved with any maintenance program which contributes to the total cost of connection selection and installation.

### **3.2.1.4 Cost of Failure**

The total cost of an electrical connection failure is difficult to fully realize as the impact is usually far-reaching. Lost revenue, cost of replacement and retrofit, and other direct external damages are quantifiable. The costs of property damage claims alone can be significant in comparison to the costs of re-tooling to eliminate future failures. However, the costs of ill will, miscellaneous claims, recalls, and other internal reaction to prevent repeat failures cannot be easily or accurately captured.

Therefore, the importance of selecting the best suited electrical connection system for the application is critical in minimizing failure costs. Costs associated with initial installation may be higher than alternative means, but the potential cost savings can be significant if the correct connector is originally installed. The theoretical and practical knowledge relating to the various electrical connection systems cited in this paper is targeted towards assisting the connection selection process to decrease and eliminate avoidable costs.

## **3.3 Safety**

Connection safety issues center around two main areas; installation and improper handling and use. Installation safety involves more factors than connector selection. How the connector is applied, the installation tooling and operational practices within the organization for a specific application all encompass the safety issue as a prime concern.

### **3.3.1 Installation Safety**

By far the most important aspect of connector safety is installation practices. Anytime work is performed near (or on) energized or potentially energized conductors, an element of danger is present. Due to the hazards associated with electrical work, many industry standards have evolved for the safety of the worker. In addition, where the means of connection involves potentially hazardous installation tooling or materials, the manufacturer will include specific information and equipment for safe work practices.

#### **3.3.1.1 Industry Standards**

Many industry standards are available for reference concerning work on or near electrical equipment. These standards go into great detail for performing electrical work safely due to the hazards involved.

The federal government produces general work safety standards through the Occupational Safety and Health Administration (OSHA), which publishes the CFR 29 Federal Code of Regulations. Contained within

CFR 29 are numerous references to use of personal protective equipment, safe electrical work practices, as well as other industry safety requirements.

IEEE (Institute of Electrical and Electronic Engineers) also publishes numerous safety work standards. The National Electrical Safety Code (NESC) specifically relates to work practices for electrical workers and utility operators. The color book series details numerous topics related to electrical safety, both in work practices and system requirements.

The National Fire Protection Association (NFPA) publishes electrical industry safety standards as well, the NFPA 70, National Electrical Code (NEC) being the most well-known. NFPA 70E Standard for Electrical Safety Requirements for Employee Workplaces is directly related to OSHA requirements for electrical safety.

### **3.3.1.2 Manufacturer's Guidelines**

When specific connector installation methods may involve a hazard to the operator, the manufacturer will provide detailed safety information. Operator's manuals, instruction sheets, and labels provided with connectors and/or tooling should be read and followed by the worker prior to performing the installation.

OSHA also regulates manufacturers for providing information on the safe storage, handling, and disposal of hazardous materials. It is important to maintain connector-related Safety Data Sheets (SDS) including oxide inhibitors, welding powders, cleaning solvents and even solders to comply with these federal regulations.

Other types of safety support provided by manufacturers may include training on handling and using their products safely, as well as tool repair and replacement programs to insure tooling meets specifications.

### **3.3.1.3 Internal Safety Programs**

Most utilities and companies develop their own internal safety programs to train, refresh and advise employees in proper safety procedures. These programs are very useful for initiating new employees to occupational hazards, as well as alerting long-time associates of new or forgotten procedures.

Comprehensive internal safety programs will often incorporate many or all of the safety advisory rules from OSHA, IEEE (NESC), NFPA and/or other similar organizations. Where the organization feels a high risk or unusual circumstance is involved with a particular task, the safety program can highlight this area and specify even stricter guidelines for processing.

## **3.3.2 Improper Handling and Use**

The mishandling and misuse of electrical connectors and related installation tooling are also important areas of safety concern. Although closely related, mishandling topics include storage, inspection, and transportation of connector related items, where misuse refers to inappropriate tool usage and misapplication of connectors.

### **3.3.2.1 Storage**

Connectors should be stored in a clean, dry environment to prevent contaminants and corrosion from damaging contact surfaces. Tooling should be stored according to manufacturers' recommendations. Hydraulic hoses should be cleaned prior to storing, and must never be kinked or wound too tightly to prevent damage. Powder powered tools and boosters and exothermic charges should be stored in clean and dry areas, and boosters should not be exposed to extreme cold, high heat or direct sunlight.

### **3.3.2.2 Inspection**

Connectors should be inspected for damage and appropriateness for the application prior to installation. Tooling and equipment should be inspected regularly for defects, wear, and signs of damage. Inspection should be and often is a significant step in equipment maintenance procedures. Tools, equipment, and/or connectors that do not meet specifications can result in safety hazards.

### **3.3.2.3 Transportation**

Manufacturers will usually take care to properly package electrical components for transit. However, since electrical connectors and installation tooling are often repackaged and transported multiple times prior to their subsequent use, care should be taken in handling these products. If connectors are too loosely packed or insufficiently protected from harsh abuse, they may become damaged. Damaged connectors can make installation difficult, and in severe cases may affect the performance of the connection. Even more important, care must be taken to protect the installation tool from damage. Tools should always be placed inside carrying cases when provided, or otherwise secured against potential breakage during transport. A damaged connector and/or tool may not perform appropriately and increases the chance of malfunction and/or injury. Special requirements may apply to powder charge boosters and exothermic charges.

### **3.3.2.4 Tool Selection and Use**

It is critical to select the correct installation tool for the job in any electrical connector installation. As aforementioned, some connectors may be installed with several different tools. In all instances, the tool should be used in accordance with the manufacturer's recommended procedures and all precautions should be followed to the fullest. Safety, Operating and Maintenance Instructions provide directions for the correct operation of the tool. Personnel should read and follow the instructions provided in manuals for safe tool practices. Incorrectly selecting or operating a tool may void its warranty and worse, could lead to serious injury.

### **3.3.2.5 Improper Application**

Misapplication of an electrical connector installation involves the incorrect connector and/or the incorrect tool, power booster or exothermic charge for the application at hand. Every effort must be made to choose the correct electrical connector (mechanical, compression, implosive or exothermic process) for the job, and the associated recommended tool for installation. Consequences of misapplication may range from burn, down to potential injury or death.

## **4.0 Summary**

Section 1, Theory of Connector Technology, covered the design principles for specific applications and all types of connections, and the critical aspects of an electrical connection system. The range of topics was broad in nature and allows for general referencing when making connector specifications. In Section 2, Connector Functions and Types, went over tapping, terminating and splicing, the main functions of connectors. Also, the many types of connectors were explained. In Section 3, Practical Connector Concepts, stressed were the importance of correct installation procedures, how infrastructure can influence selection of and the safety concerns for connectors and installation methodologies. The information provided between the two sections may be used together or in part for managing a comprehensive connector specification program. It is believed that most of the concerns involved with connector design, specification, selection, installation, and performance have been touched upon, and may be utilized as is, or further developed as seen fit by the end customer.



## 5.0 Bibliography

- [1] ANSI C119.4 Connectors for Use Between Aluminum-to-Aluminum or Aluminum-to-Copper Bare Overhead Conductors, American National Standards Institute, NY, 1991.
- [2] Bolden, G., Duffy, J., A Study of the EUA System Secondary Networks, Eastern Utilities Associates Service Corp., presented at The Electric Council of New England Transmission and Distribution Committee Meeting No. 82, September 17, 1982.
- [3] Brooks, A. S., Grounding and Bonding, Proc. AIEE, 1960.
- [4] Basic Crimping Technology, Product Manual, Sec. 16A, BURNDY Power Group, 1973.
- [5] Equipment for Underground Systems, Catalog Z47, BURNDY Engineering Co., 1947.
- [6] Underground Distribution Equipment, Catalog UN63, BURNDY Corporation, 1965.
- [7] DiTroia, G. W., Principles of Connections Used for Grounding, FCI-BURNDY Electrical, unpublished, 1995.
- [8] Dupree, H. P., The Problems Involved in Designing Connectors for Aluminum Cable, AIEE Paper 51-325, 1951.
- [9] Dupree, H. P., Rogoff, J., Splicing and Terminating Aluminum Conductors, BURNDY Corporation, 1952.
- [10] Connectors and Interconnections Handbook, the Electronics Connector Study Group, Fort Washington, PA, 1977.
- [11] Transmission Line Reference Book, EPRI, Palo Alto, CA, 1979.
- [12] 1993 National Electrical Safety Code, Institute of Electrical and Electronic Engineers, Inc., New York, 1992.
- [13] IEEE Guide for Safety in AC Substation Grounding, Institute of Electrical and Electronic Engineers, Inc., New York, 1986.
- [14] IEEE Recommended Practice for Grounding of Industrial and Commercial Power Systems, Institute of Electrical and Electronic Engineers, Inc., New York, 1992.
- [15] Kurtz, Shoemaker, The Lineman's and Cableman's Handbook, McGraw Hill, 1981.
- [16] Leland, M. A., Bolted and Welded Substation Connections, Proc. AIEE, 1958.
- [17] Matthysee, I. F., Basic Connection Principles, Second edition, BURNDY Corporation, 1965.
- [18] Matthysee, I. F., Is It Necessary to Retighten Clamp Connectors?, Electrical World, May, 1951.
- [19] McPartland, J. F., Why Not Torque All Terminations?, Electrical Construction and Maintenance, November, 1977.

- [20] McPartland, J. F., All Electrical Terminals Must Be Torqued!, Electrical Construction and Maintenance, 1983.
- [21] McPartland, J. F., Torquing Electrical Terminals Will Soon Be Mandatory!, Electrical Construction and Maintenance, 1985.
- [22] Monashkin, M. R., Converting Connection Applications into Connector Recommendations, BURNDY Corporation, 1977.
- [23] Monashkin, M. R., Preparation of Aluminum Conductors for Stable Electrical Connections, AIEE Paper 58-1288, 1958.
- [24] Military Handbook MIL-HDBK 419A, Vol. 1, Department of Defense, Washington, 1987.
- [25] NFPA 70E Standard for Electrical Safety Requirements for Employee Workplaces, National Fire Protection Association, Quincy, MA, 1995.
- [26] NFPA 70 the National Electrical Code, National Fire Protection Association, Quincy, MA, 1996.
- [27] Code of Federal Regulations 29 CFR 1900 to 1910, Office of the Federal Register National Archives and Records Administration, Washington, DC, 1994.
- [28] Pansini, A., Basic Electrical Power Distribution, Long Island Lighting Co., Vol. 1 and 2, 2nd Edition, 1971.
- [29] Raila, E., Grounding Connector Design, Proc. IEEE, 1964.
- [30] Shackman, N., Belleville Washers. Who Needs Them?, CEE, 1975.
- [31] UL467 Standard for Grounding and Bonding Equipment, Underwriters Laboratories Inc., Northbrook, IL, 1993.
- [32] Zahlman, G., Report to Dow Chemical Company, FCI-BURNDY® Electrical, internal document, 1996.

[www.burndy.com](http://www.burndy.com) | 1-800-346-4175



**Customer Service Department**

7 Aviation Park Drive  
Londonderry, NH 03053  
1-800-346-4175  
1-800-451-4956 (Technical Services)  
1-603-647-5299 (International)

**Canada**

1-800-361-6975 (Quebec)  
1-800-387-6487 (All other provinces)

**Mexico**

011-52-722-265-4400

**Brazil**

011-55-11-5515-7225

**Tool Service Center**

Littleton Industrial Park  
Littleton, NH 03561  
1-800-426-8720

Item # 591717



**Connecting** Power to Your World®

